

## THE DETERMINATION AND ANALYSIS OF TIRE CONTACT SURFACE GEOMETRIC PARAMETERS

Cristian MINCA

Timisoara, Romania

**Abstract:** In the paper are presented the comparison between theoretical and practical research under different conditions regarding to contact patch between tire and undistortable road in static conditions without applying transversal forces. It is determined and analyzed the variation of geometric parameters of the contact patch (the shape, the dimensions, and the surface of contact patch) depending on the load applied over the tire and the air pressure into the tire. Also, it was determined and analyzed the influence of radial load and the air pressure against the surface of the contact patch. Starting from the probable theory, it was initiated an experimental demonstration with the help of a special stand built in the university's laboratory.

**Keywords:** contact patch, deformation, vertical load, tire air pressure, geometric parameters.

### INTRODUCTION

The contact patch is formed due to interaction between tire and road where inside it normal stresses and longitudinal and lateral tangential stresses are developed. The functional, constructive and dimensional parameters of the tire as well as the nature and the type of the surface of the road or the level of damage of the above mentioned parameters it influences the forces that are transmitted through the contact patch.

The shape and the size of the contact surface between tire and road depend on many factors, among them are tire's characteristics, road's type and the forces applied to the tire. *The influences of different factors against the contact surface are the following:*

- Tire's vertical deformation changes approximately linearly the gross area of the contact surface;

- The running speed changes the shape of the contact patch making the gross area bigger;

- The tread design produces a decrease in the effective surface of the contact area between tire and road.

An increase of the static load of the tire leads to a growth of pressures in the contact patch as well as it increase the surface of the contact patch.

An increase of tire's air pressure leads to a raising of stresses in the contact patch, combined with increasing vertical load.

### 1. METHODS

**The methodology to experimental determine geometric parameters of contact surface.**

The stand presented below consist of a frame (5) on which is gantry, in position 4, a bar (2) and on which is fixed the wheel 165 R 13 (1) through the axle (3).

By shifting the weight ( $G_s$ ) on the bar (2) the wheel is radial loaded with different weights. The support surface of the tire is the platform (6) rigid fixed on the frame (5). The indicator (7) rigid fixed on the axle (3) indicate on the ruler (8) static radius value, corresponding to the applied load.

To determine the tire air pressure it is necessary to utilize a manometer.

The tire is radial loaded by placing the weight  $G_s$  on the bar (2) at a certain distance ( $l_s$  [m]) to the axes (4) afterwards it has to read the static radius value on the ruler (5).

The normal load of the tire is given of the stand characteristic equation:

$$G_R = G_S \cdot \frac{l_s}{0.315} + 490,223 \quad [\text{N}] \quad (1)$$

Where:  $G_s$  calibrated mass weight of 50 kg

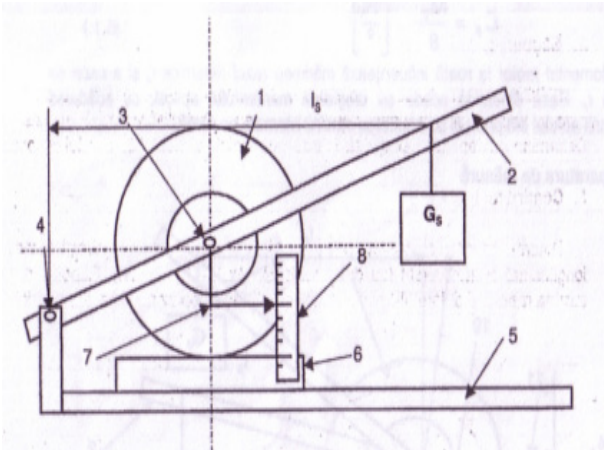

Fig. 1: Functional scheme of the static test stand

For analyzing the contact surface it has to upload the tire with a weight, to establish a tire air pressure, to moisten with ink approximate footprint outline of the contact patch on the tire.

By imprinting on a graph paper (A4 format) it is obtained the geometric shape of the contact patch.

The total area of the contact patch is given by the contour area footprint on the graph paper.

The effective area is determined by counting the stains from the graph print.

**The experimental determination of geometric parameters of the contact surface.**

For this analyze were established beforehand seven values for the tire air pressure (1,2; 1,4; 1,7; 2; 2,2; 2,6 and 2,9 bar) and also, seven shifts on the bar load with radial weight (1; 1,25; 1,5; 1,75; 2; 2,25; 2,5 m) which offer us seven different load in the limit of 2000-4400 N.

It obtained, totally, 49 contact patches.

The aim of the experiment is to establish the dependence between geometric parameters of the contact patch and the absolute radial deformations of the tire with the vertical load and tire air pressure.

The final results afford us to test certain empiric equations regarding to the shape of the stain which are found in the specific literature. In the pictures 2-5 it is found the evolution of the contact patch's shape and size with the vertical load and tire air pressure.

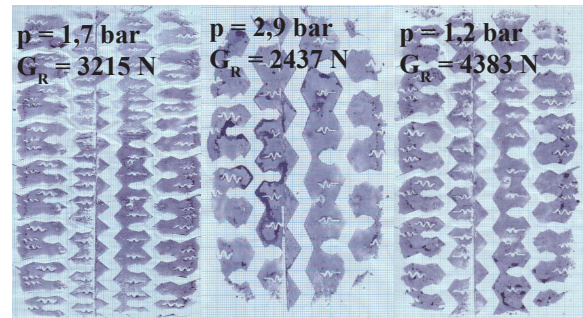

Fig. 2: Tire footprint

The analysis assumed to establish the limit's coordinates of the contact patch with the ink for the patch regarding to Cartesian coordinate system spot at the center of the x-axis along its length and the width of the y-axis.

Analyzing the result of measurements it shows that the footprint is rectangular with rounded corners except the corresponding stains for the vertical light weight and higher air pressure in the tire, these footprints have an elliptic form and that the transition from an elliptical to one rectangular with rounded corners.

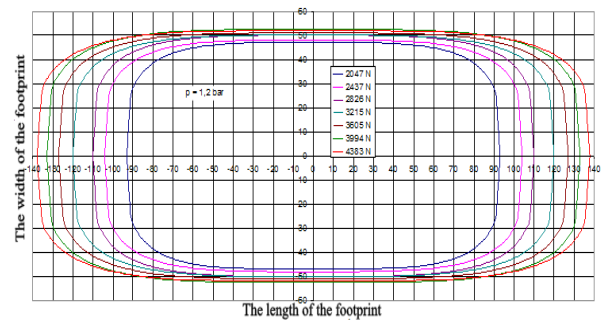

Fig. 3. Variation of the shape and the size of the footprint according to the vertical load and the air pressure  $p= 1,2$  bar

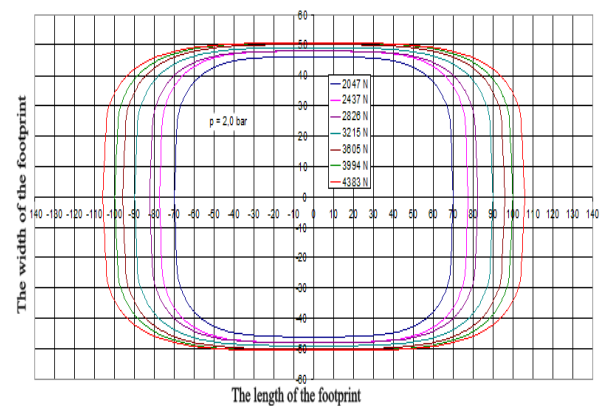

Fig. 4. Variation of the shape and the size of the footprint according to the vertical load and the air pressure  $p= 2,0$  bar

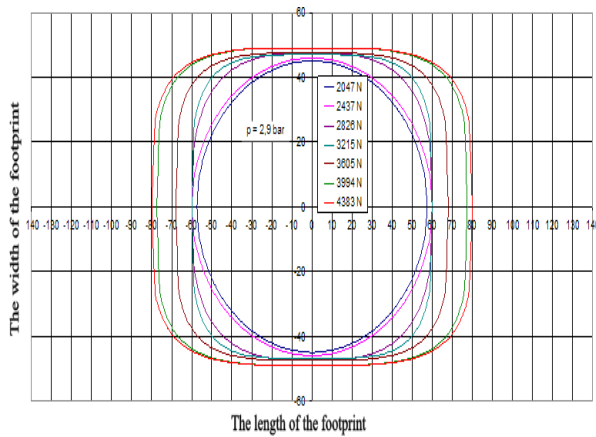

Fig. 5. Variation of the shape and the size of the footprint according to the vertical load and the air pressure  $p = 2,9$  bar

Also, there is little variation of the semi-width of the contact patch with the vertical load and the air pressure of the tire. The extreme limits measured have ranged between 45 and 52 mm at a width of the tread of 100 mm, it results a deviation of  $-10\% \dots +4\%$ , but the extreme measures are outside of the tire features so, in this case it can be accepted that the width of the tire-road contact patch is the same with the tire tread.

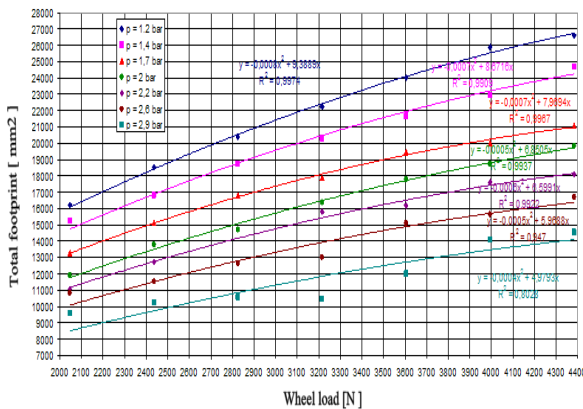

Fig. 6. The influence of the vertical load and of air pressure from the tire against contact patch area

In the figure 6 is the variation of the total contact area, according to vertical load and air pressure from the tire.

It can be seen a parabolic dependence between total contact area and vertical load for all tire air pressures utilized for all rehearsals, the value of the linear correlation coefficient ( $R^2$ ) ranging between 0,803 and 0,997.

Because of afore mentioned accuracy it can be accepted, even generalize, regression function of the parameters involved.

An important result is the equation of effective area and total area:  $A_{effective} / A_{total} = 0,687 \dots 0,718$ ,

with an average of 0,7 which is characteristic for new summer tire.

Regarding to influence of the pressure against contact patch area, picture 6, it observes that there is a parabolic dependence similar for all attempts with vertical load.

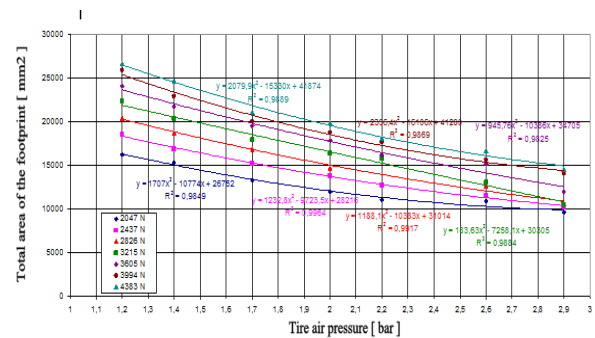

Fig. 7: The variation of the contact patch according with tire air pressure

Knowing the total and effective area of the contact patch it can be determined the influence of the vertical load and tire air pressure against two synthetic parameters, picture 8, utilized in reality, such as:

-apparent average pressure in the stain:

$$p_m = \frac{G_R}{A_{total\grave{a}}} \quad (2)$$

-effective average pressure in the stain:

$$p_m = \frac{G_R}{A_{effectiv\grave{a}}} \quad (3)$$

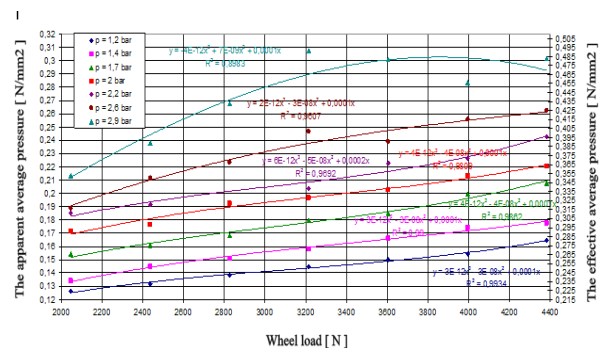

Fig. 8. The variation of apparent and effective average pressure in the stain with vertical load

This analysis is important due to the connection between static radius, vertical load and contact patch length in professional literature [2] under analytical form and equivalent mechanic model Elastic Foundation Approach (EFA) which suggests dependence on below expression (cylindrical sector's cord of tire in contact with the path is equal to the length of the contact patch)

$$\begin{aligned} \delta_x &= \sqrt{r^2 - x^2} - r_s = \sqrt{r^2 - x^2} - \sqrt{r^2 - b^2} \Rightarrow \\ p_z(x) &= k \cdot (\sqrt{r^2 - x^2} - \sqrt{r^2 - b^2}) \\ p_0 &= k \cdot \delta_0 = k \cdot (r - \sqrt{r^2 - b^2}) \Rightarrow \\ p_z(x) &= p_0 \cdot \frac{\sqrt{r^2 - x^2} - \sqrt{r^2 - b^2}}{r - \sqrt{r^2 - b^2}} \end{aligned} \quad (4)$$

The Elastic Tire Approach (ETA) model suggests the dependency between static radius and vertical load for all tire air pressures:

$$r_s = r_j \cdot \cos\left(\frac{b}{r}\right) + \sqrt{(r - r_j)^2 - \left(b - r_j \cdot \sin\left(\frac{b}{r}\right)\right)^2} \quad (5)$$

It was observed that for all pressures the correlation coefficients of theoretical radius EFA and ETA overcome 0,9653 even 0,999.

However, concurrently with the increasing vertical load the deviation of theoretical radius is more significant as providing a smaller radius than real radius observation applies to all the pressures and both theoretical models.

If we take into consideration that the theoretical calculation of static radius entering experimental parameters – length of the contact patch- and taking into account that the deviation of the radius is very small compared to the experimental beam is unidirectional, it can be concluded as follows, namely: the tire footprint experimentally obtained on the graph paper is slightly smaller than the real mark, the explanation is the fact that at the extremes of the contact patch the pressure is very low, insufficient to transfer the ink from the tread of the wheel on the paper.

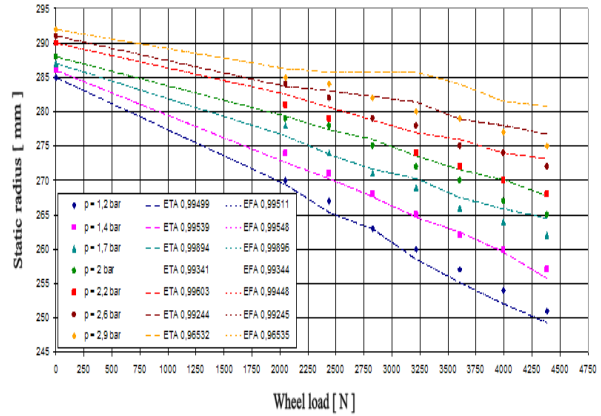

Fig. 9. The dependence of static radius and vertical load

Accepting above mentioned hypothesis and applying a correction to the length of contact patch it was noticed a significant increase in the correlation coefficient it reaching 0,999.

The analysis was numerically carried out and the correction was decreasing with the increase of pressure starting from 10 mm to 5 mm.

However, this observation does not change considerably the analyze mode of interaction tire-road due to normal stresses acting on the extension of the spot are practically zero.

From the analysis of experimental data it can be extracted the influence of vertical load and the tire air pressure on a global radial tire stiffness of the tested tire, the stiffness given by the expression:

$$k_r = \frac{G_R}{\Delta z_{\max}} \quad (6)$$

It is noteworthy that the stiffness coefficient thus calculated can induce significant errors because it envisages only extreme values of the vertical load and the deformation.

The figure 9 presents the influence of vertical load and the tire air pressure an radial stiffness, it is observed that for the same air pressure of the tire, the stiffness coefficient changes a little (slightly decrease with the vertical load), the deviation from an average value is not more than 7% in this context one can neglect the influence on the vertical load on radial elasticity.

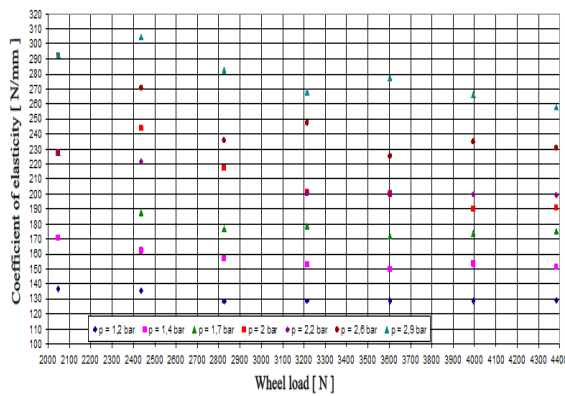

Fig. 10: The dependence of radial stiffness coefficient of vertical load and the air pressure of the tire

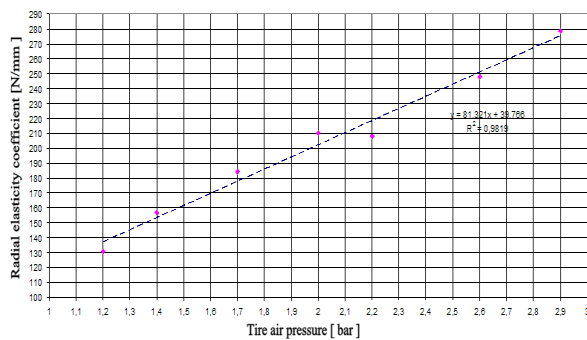

Fig. 11: The variation of elasticity coefficient with air pressure of the tire

The figure 11 presents the variation of the average values obtained for the radial elasticity coefficient with tire air pressure, there is a linear dependence with the tire air pressure given by the expression:

$$K_r = 81,32 \cdot p_{aer} + 39,76 \quad R^2 = 0,98 \quad (7)$$

Afore mentioned expression of correlation offers us the elasticity share due to tire air pressure from total share, thus for a tire air pressure of 2.....2,2 bar the share of air elasticity ranges from 80-81% of the total.

The values obtained from the analyzed tire correspond to accepted average from professional literature which is 80-85% from the total stiffness expression.

## CONCLUSIONS

From the test made to determine the footprint’s geometrical parameters it was found that the tire footprint is rectangular with rounded corners without taking into consideration the tire footprints which correspond to small vertical load on the tire and high tire air pressure, the latter presents an elliptic shape and respectively an elliptic shape toward a rectangular shape with rounded corners.

Also, it can be observed a small variation of semi-width of the contact patch with the vertical load respectively tire air pressure, so the extreme limits measured have ranged between 45 and 52 mm at the actual tread width of 100 mm, it results a deviation of -10%.....+4% if we consider that the extreme values were obtained for loads beyond the prescribed limits for such a tire when the significance level is acceptable that the width of the contact patch between tire and road is the same with the tire tread.

The vertical load and tire air pressure influence the contact patch surface noting parabolic dependence of the total area of contact and vertical load for all utilized pressures in the test, the value of the correlation coefficient (R2) ranging between 0,803 and 0,997.

Such a confidence level is acceptable, even generalize the regression function of the parameters involved.

**BIBLIOGRAPHY**

1. Angelache, G, Negruș.E.și Ciubotaru O. Investigation of shear stress in the tire-road contact patch S.A.E. Paper No. 2003-01-1273 Detroit S.U.A.
2. Cipleu A., ș.a., Elastic tire approach (II) Static analysis, Sc.Bull. of UPT Tom 53(67) pp. 29-34 (2008).
3. Cipleu A., ETA– Elastic tire approach dynamic steady-state analysis, Sc.Bull. of UPT Tom 53(67) pp. 35-38.
4. Cipleu A., On the study of tire-hard pavement static interaction (I), theoretical approach, MVT Conf., Timisoara pp. 19-26 (2008).
5. Cipleu A., Mincă C., ș.a., On the study of tire-hard pavement static interaction (II), experimental and modelling approach, MVT Conf., Timisoara pp. 27-36, (2006)
6. De Beer, M. ș.a. -Contact Stress of the 11.00-R 22,5 Pneumatic Radial Tiers on the Gautrans Heavy Vehicle Simulaton (HVS) measured with the Vehicle- Road Pressure Trasducer Array (VRSPTA) CSIR Transportek South Africa Martie, (2000).