



"HENRI COANDA"  
AIR FORCE ACADEMY  
ROMANIA



"GENERAL M.R. STEFANIK"  
ARMED FORCES ACADEMY  
SLOVAK REPUBLIC

INTERNATIONAL CONFERENCE of SCIENTIFIC PAPER  
AFASES 2015  
Brasov, 28-30 May 2015

## INFLUENCE OF THE INTERCONNECTING CABLES ON EQUIPMENTS ELECTROMAGNETIC EMISSIONS SPECTRUM

**Dan Stoica\*, Adina Boteanu \*, Mihai Enache\*, Albert Ploșniță\***

\*Information Systems and Communications Test & Evaluation Scientific Research Center,  
Military Equipment and Technologies Research Agency, Bucharest, Romania

**Abstract:** *This paper presents the results of some experimental activities carried out in our specialized electromagnetic compatibility laboratory for equipments emissions analysis. It is in the interest of all sensitive information processing equipments owners to invest in data security measures but with respect to a reasonable budget. At the present the most common methods to prevent electromagnetic data leakage are represented by electromagnetic shielding solutions. Not always these solutions are the most efficient way to solve data security problem, especially from economical point of view. Our paper presents some aspects regarding interconnecting cables influence on the system vulnerability. It represents a starting phase in a bigger project that aims to adapt and optimize shielding methods for data electromagnetic leakage prevention.*

**Keywords:** *shielding screen, electromagnetic, EMC*

### 1. INTRODUCTION

Electromagnetic interferences represent the energy levels introduced by electronic or electrical devices that have a negative effect on other equipments, regarding their functionality. Any electronic equipment is affected by interferences in a moderate or more severe manner.

Electromagnetic screening represents the most common solution used to protect equipments or their components from the outside electromagnetic environment and vice versa. It represents also a good way to secure data processing equipments by preventing electromagnetic emissions leakage.

The idea behind these techniques is to ensure high attenuation of the electromagnetic radiated field that passes through a screen in

order to reduce the data integrity carried out by these emanations [10].

In the design phase it is necessary to analyze, select and optimize all the adequate shielding techniques, in order to fulfil special EMI/EMSEC protection requirements at the lowest design level possible.

For this reason, electromagnetic shielding solutions design and implementation is a complex task to achieve, and it sometimes involves special design and simulation software. Sometimes, the electromagnetic protection solution is very simple and consists in efficient methods appliance like components isolation, equipment grounding or replacing the original cables with proper shielding ones.

We believe that EMC testing and analysis could be also optimized by offering more

detailed information about interference sources, conducting specific tests.

This paper presents a case study regarding video displays interconnecting cables. The aspects concluded could be extended to other typical IT and communications equipments sources.

## 2. SHIELDING THEORY

The shielding effectiveness, noted  $SE$ , is an important parameter [1-6] for the characterization of an electromagnetic screen and is defined as the report between the field's intensity (electric or magnetic) measured without screen  $E_s$  and with screen  $E_0$ .

$$SE = 20 \cdot \log \left( \frac{E_s}{E_0} \right) \quad (1)$$

or 
$$SE = 10 \cdot \log \left( \frac{P_i}{P_t} \right) \quad (2)$$

In the same time  $SE$  could be obtained as a ratio between the field strength, at a given distance from the source, without the shield interposed ( $P_i$ ) and the field strength with the shield interposed ( $P_t$ ).

A screen action on the electric or magnetic field through the following mechanisms:

- absorption (characterized by the factor of attenuation through absorption  $A$ )
- reflection (characterized through the factor of attenuation through reflection  $R$ )
- multiple scintillations (with significant effects in the thin screen's case) (characterized through the factor of attenuation through scintillations  $R_r$ ).

Expressing the attenuations  $A$ ,  $R$  and  $R_r$  in dB, it's obtained, through their summarization, the (total) efficacy  $SE$  of the screen.

$$SE = A + R + R_r \quad (3)$$

where:

$R$  - the factor of attenuation through reflection at the frontier surfaces,

$A$  - the factor of attenuation through absorption within the screen (the transformation of the electromagnetic energy in heat through the losses due to currents circulation through the screen),

$R_r$  - the factor of attenuation that considers

the multiple scintillations in the inside of the screen.

The efficacy of the screening depending on: the perturbation source's frequency, the material of the screen (generally: copper, iron, aluminum), the field's type that must be attenuated (electric, magnetic, TEM), the screen's geometry (parallelepiped, cylindrical, spherical, etc.), the incidence angle of the field, etc.

Frequently though, it's worked with the inverted value,  $\delta$  ( $\delta = 1/\alpha_d$ ), called, penetration depth. This represents the distance from the incidence surface in the conducting material to which the field applied on the surface decreases to level 0.368 ( $e^{-1} = 0.368$ ) compared to the value from the incidence surface of the material.

Analytically, the penetration depth is described through the relation:

$$\delta = \frac{1}{\sqrt{\pi f \mu \sigma}} \quad (4)$$

from where results that the value varies proportionally inverse with the electromagnetic field applied on the screen's surface and with the material's conductivity the screen's made of.

Attenuation by reflection is the difference between the incident wave  $E_0$  and the out wave of the screen  $E_d$ :

$$R = 20 \log \frac{E_0}{E_d} = 20 \log \frac{|Z_1|}{4 \cdot |Z_2|} \quad [dB] \quad (5)$$

The reflection losses do not depend on the thickness of the screen just on the screen impedance values or environmental impedance.

The attainment of an efficient screening implies, among others, the use of a material that has low permeation depth.

In conclusion, the electromagnetic shielding solution will be adapted to the specific protection requirements by choosing material type and construction. As a first step in our project we wanted to evaluate these requirements and the influence of the products parameters (length, position and grounding) on the overall system vulnerability.



"HENRI COANDA"  
AIR FORCE ACADEMY  
ROMANIA



"GENERAL M.R. STEFANIK"  
ARMED FORCES ACADEMY  
SLOVAK REPUBLIC

INTERNATIONAL CONFERENCE of SCIENTIFIC PAPER  
AFASES 2015  
Brasov, 28-30 May 2015

### 3. CONFIGURATION SETUP

In our testing activity, we focused on VGA card signals analysis and measurements, conducting investigations on a reference electromagnetic shielded central unit, in order to minimize electromagnetic noise background during emissions tests. All tests was carried inside our specialized laboratory using measurements equipments like oscilloscope, spectrum analyzer, antennas, shielded cables, connectors and specialized software applications.

VGA typical electric signals are composed by synchronization (H, V) signals and data channels (R, G and B). We have been tested different display settings and various images.

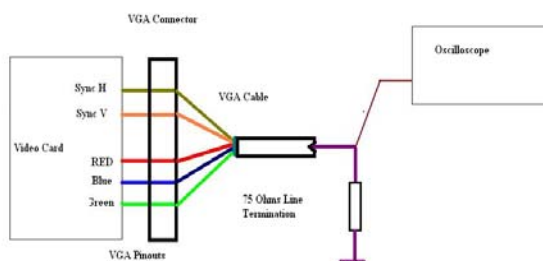

Figure 1. VGA card signals measurements and image setup

For instance, in this paper are presented the results obtained for a 32 bits VGA card working on 1280x1024@75 Hz resolution, using a simple test image that consists in a black background with 3 parallel red horizontal lines.

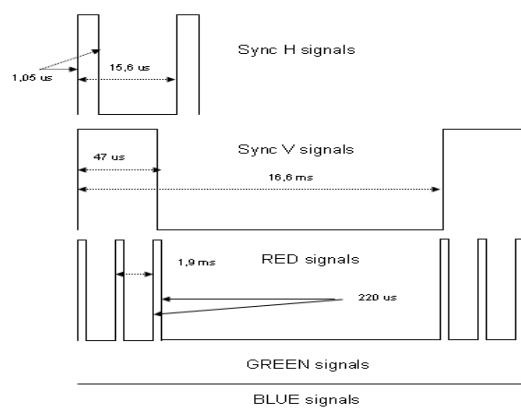

Figure 2. VGA card signals measured parameters for reference image

The measurement results are displayed in figure 2. These values represent reference parameters that will be compared with received signals during EMC tests.

Analyzed signal sources could be present in the equipment radiated emissions as a normal consequence of electromagnetic field propagation. Such correlated emissions may occur as a direct base-band or high harmonic radiation and also as a modulation of other high frequency signals present in the internal equipment components.

Based on initial measurement results we tried to identify in the 50 – 1000 MHz band correlated emissions with these signal sources. Tests were conducted in accordance with standard EMC radiation procedures, using current measurement platform, presented in fig. 3.

In order to minimize effects of other signals we used a shielded computer central unit (TEMPEST product), containing measured VGA card for exciting 2 different standard VGA cables: 1.8 meter length, 1 meter length, in both planes of polarization.

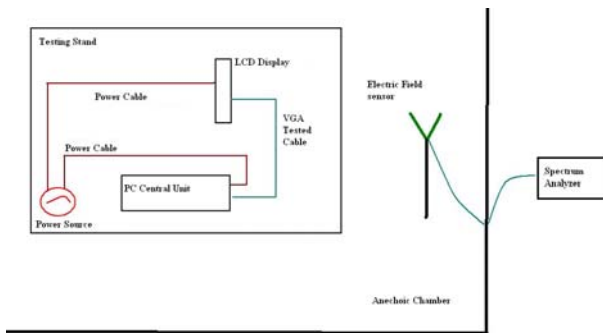

Figure 3. Emission radiation measurement setup

#### 4. EXPERIMENTAL RESULTS

Electromagnetic field measurements were conducted in a semi-anechoic chamber, using a receiver system composed by a bi-conilog antenna and a wideband EMI receiver. We made spectrum measurements for each cable as it's presented below (figure 4, 5).

All these data represents electromagnetic spectrum radiated by the equipment and its cables. As we said before we used a shielded central unit with shielded and filtered power cable and the VGA cables 75 ohms ended.

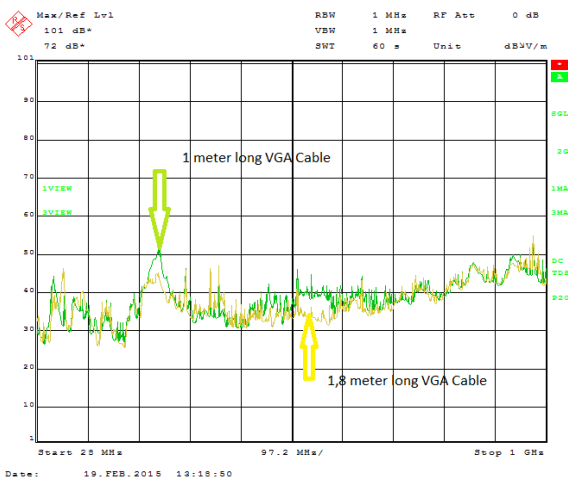

Figure 4. Radiated Emissions levels in 28-1000 MHz for different cable lengths

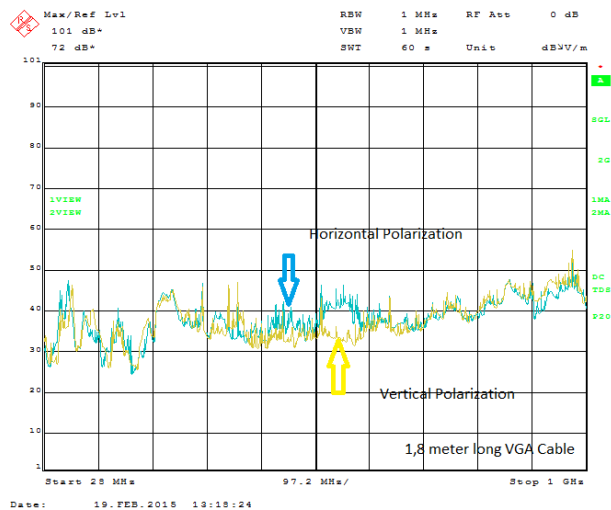
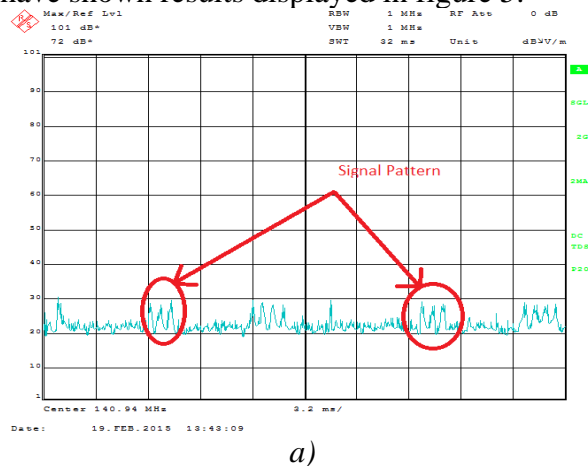
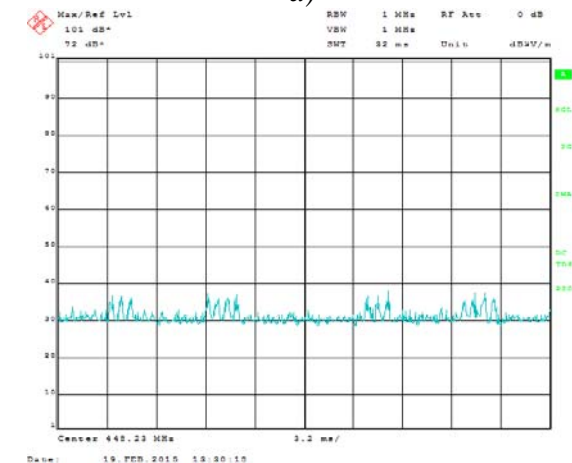

Figure 5. Radiated Emissions levels in 28-1000 MHz polarization V and H

As other research works in the display data units eavesdropping field [7-9] we identified correlated emissions with reference video signal around pixel frequency, respectively 134.18 MHz (for 1280x1024@75 Hz resolution). Manual searches conducted for each configuration, in this spectrum band, have shown results displayed in figure 5.



a)



b)



"HENRI COANDA"  
AIR FORCE ACADEMY  
ROMANIA



"GENERAL M.R. STEFANIK"  
ARMED FORCES ACADEMY  
SLOVAK REPUBLIC

INTERNATIONAL CONFERENCE of SCIENTIFIC PAPER  
AFASES 2015  
Brasov, 28-30 May 2015

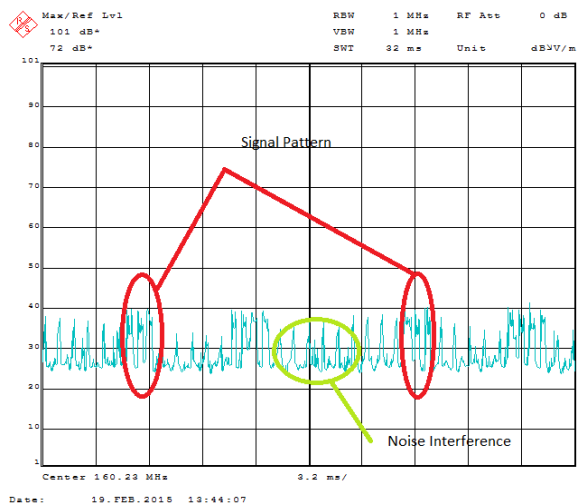

c)

Figure 6. Time domain manual measurement for investigated emissions: a) 1,8 meter cable, 140 MHz emission; b) 1 meter cable, 448 MHz emission c) H-plane polarization, 160 MHz emission

In all three configuration setups (140 MHz emission, 448 MHz emission, 160 MHz emission) the equipment presented evident vulnerabilities, even if the measured spectrum seems to be different for each one. As it is presented in figure 6, each EUT could be identified by video card signals intercepted by his own unintentional emissions. The difference between them is that EUT present the main vulnerability at different frequencies. It could be explained by the multiple interference sources presence in the same time on the same transmission cable. An emission is better propagated if the electrical length of the equivalent antenna is closer to the wavelength fraction (with respect to the ground).

The EMC standard measurements in the 100-500 MHz band require resolution bandwidth of 100 KHz and a minimum dwell time of 15 ms. These conditions assure to

evaluate effect of mostly present signal sources inside equipment, but will not offer correct bandwidth for wideband signals analysis. Considering all these aspects we performed personalized tests for properly electromagnetic data acquisition.

Recorded data on spectrum analyzer it's not enough to conduct proper offline frequency domain analysis in larger bandwidths, because of storage hardware limitations. All tests carried out limited data records to 500 points/measurement, far from resolution needs on this scenario.

In figure 7 are presented some image reconstruction results obtained in our testing laboratory by EUT unintentional emission processing and analysis.

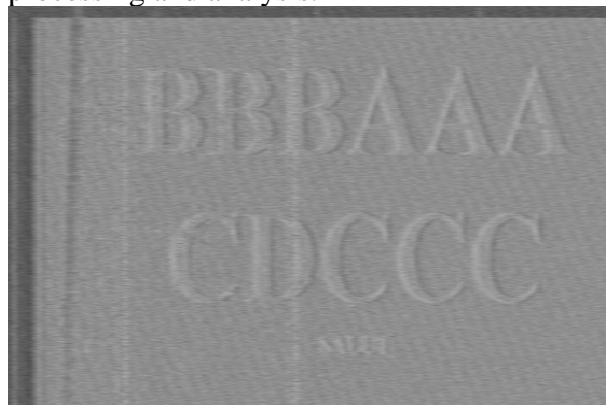

Figure 7. Software reconstruction of initial image from VGA cables unintended emanations

## 5. CONCLUSION

This paper describes a work covering some aspects of the EMC and EMSEC testing and evaluation techniques for improving customer feedback.

EMC or EMSEC evaluations are not formal testing activities and customer expected

feedback is not always satisfying if it is reduced to yes/no, or compliant/incompliant especially in development and integration stages of the product.

As we presented already, the influence of the interconnecting cables on the overall system vulnerability exists but it's more significant in the EMSEC field than EMC.

There are ways to improve an existing system quality, from this point of view, by simply replacing a regular cable with a shielded one or just increasing cables length for wideband signals.

The present paper is a first step approach to the problem of electric and electronic equipments interference signal sources detection and identification. The electromagnetic protection measures should be chosen according to the firstly evaluated equipment vulnerabilities.

#### REFERENCES

1. Armstrong R., *Measurement of shielding in electrically large metallic enclosures*, University of York, February 2013
2. Celozzi, S., Araneo, R., Lovat, G. *Electromagnetic Shielding* IEEE Press, Wiley-Interscience a John Wiley & Sons, Inc. Publication, Mar.2008, ISBN : 978-0-470-05536-6
3. Chung, D. D. L., *Electromagnetic interference shielding effectiveness of carbon materials*, Carbon, vol. 39, no. 2, pp. 279-285, Feb. 2001.
4. Clayton R. Paul, *Introduction to electromagnetic compatibility*, Second edition, John Wiley & Sons, Inc. Publication, February 2006, ISBN : 978-0-471-75500-5
5. Erhart Moller, *Protective Measures Against Compromising Electro Magnetic Radiation Emitted by Video Display Terminals*.
6. Gainsville, VA: Interference Control Technology, 1988
7. Markus G. Kuhn, Ross J. Anderson, *Soft Tempest: Hidden Data Transmission Using Electromagnetic Emanations*. Information Hiding Proceedings, 1998.
8. Markus G. Kuhn, *Compromising emanations: eavesdropping risks of computer displays*, Technical Report, 2003.
9. Robinson, M. P., Thomas, D. W. P., Dawson, J. F., Porter, S. J., Christopoulos, C., *Design of EMC shielding*, 1997 The Institution of Electrical Engineers, Savoy Place, London WC2R OBL, UK
10. White, D. R. J., Mardiguian, M., *Electromagnetic Shielding: A Handbook Series on EMI and Compatibility*, vol. 3.