

# Review of the Air Force Academy

The Scientific Informative Review, Vol. XVI, No.3 (38)/2018  
DOI: 10.19062/1842-9238.2018.16.3

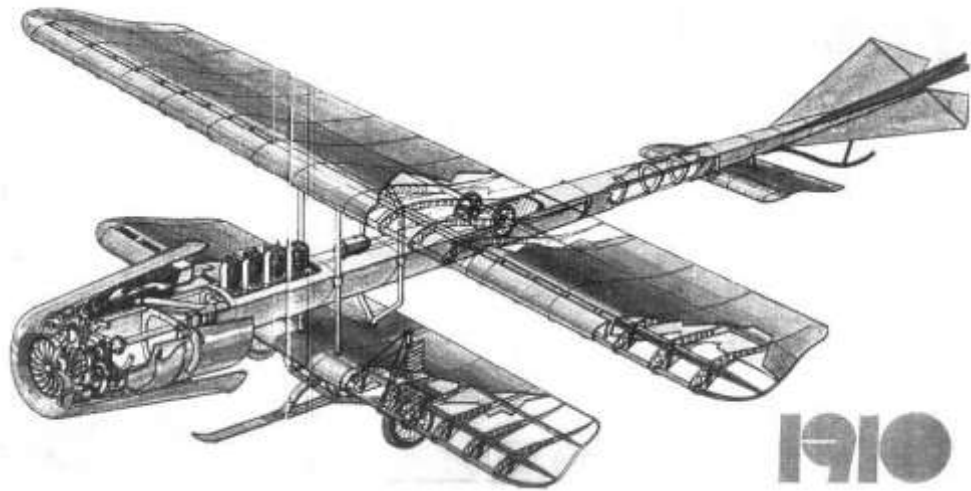

**BRAȘOV - ROMANIA**

## SCIENTIFIC ADVISERS

**Col Assoc Prof Gabriel RĂDUCANU, PhD**  
Rector of "Henri Coandă" Air Force Academy, Braşov,  
Romania

**LtC Prof Adrian LESENCIUC, PhD**  
Vice-rector for Science, Henri Coandă Air Force Academy,  
Braşov, Romania

**Assoc Prof Hussain Al SHAROUFI, PhD**  
Gulf University for Science and Technology, Kuwait City,  
Kuwait

**Assist Prof Eng Titus BĂLAN, PhD**  
Transilvania University of Braşov, Braşov, Romania

**Assoc Prof Ionuţ BEBU, PhD**  
George Washington University, Washington, DC, USA

**Assoc Prof Daniela BELU, PhD**  
Henri Coandă Air Force Academy, Braşov, Romania

**Prof Sergiu CATARANCIUC, PhD**  
State University of Moldova, Chişinău, Republic Moldova

**Prof Sorin CHEVAL, PhD**  
Henri Coandă Air Force Academy, Braşov, Romania

**Prof Philippe DONDON, PhD**  
ENSEIRB, Talence, Bordeaux, France

**Prof Alberto FORNASARI, PhD**  
Aldo Moro University, Bari, Italy

**Col Assoc Prof Laurian GHERMAN, PhD**  
Henri Coandă Air Force Academy, Braşov, Romania

**Prof Attila HORVÁTH, PhD**  
National University of Public Services, Budapest, Hungary

**Col Assoc Prof Dumitru IANCU, PhD**  
Nicolae Bălcescu Land Forces Academy, Sibiu, Romania

**Prof Indira JUNGHARE, PhD**  
University of Minnesota, Minneapolis, MN, USA

**Prof Zbyšek KORECKI, PhD**  
University of Defense, Brno, Czech Republic

**Prof Mihail ORZEAŢĂ, PhD**  
Apollonia University, Iaşi, Romania

**Prof Armela PANAJOTI, PhD**  
Ismail Qemali University, Vlora, Albania

**Prof Cristian PREDA, PhD,**  
University of Rouen, Rouen, France

**LtC Assoc Prof Aurelian RAŢIU, PhD**  
Nicolae Bălcescu Land Forces Academy, Sibiu, Romania

**Prof Daniela ROŞCA, PhD,**  
University of Craiova, Craiova, Romania

**Prof Eng Florin SANDU, PhD**  
Transilvania University of Braşov, Braşov Romania

**Prof Róbert SZABOLCSI, PhD**  
Obuda University, Budapest, Hungary

**Prof Mariselda TESSAROLO, PhD**  
Padua University, Padua, Italy

**Prof Bledar TOSKA, PhD**  
Ismail Qemali University, Vlora, Albania

**Assoc Prof Alexandru Nicolae TUDOSIE, PhD**  
University of Craiova, Craiova, Romania

## EDITORIAL BOARD

### EDITOR-IN CHIEF

**LtC Assoc Prof Catalin CIOACA, PhD**  
"Henri Coandă" Air Force Academy, Braşov, Romania

### EDITORIAL ASSISTANT

**Assist Prof Ramona HĂRŞAN, PhD**  
"Henri Coandă" Air Force Academy, Braşov, Romania

### EDITORS

**Assist Prof Liliana MIRON, PhD**  
"Henri Coandă" Air Force Academy, Braşov, Romania

**Assist Prof Bogdan MUNTEANU, PhD**  
"Henri Coandă" Air Force Academy, Braşov, Romania

**Assist Prof Vasile PRISACARIU, PhD**  
"Henri Coandă" Air Force Academy, Braşov, Romania

### PRINTING

**Eng Daniela OBREJA**  
"Henri Coandă" Air Force Academy, Braşov, Romania

### DESIGNER

**Eng Mariana GHINDĂOANU**  
"Henri Coandă" Air Force Academy, Braşov, Romania

**Inf Adina DOBRIŢOIU**  
"Henri Coandă" Air Force Academy, Braşov, Romania

© December, 2018

Visa 0574-12/2018

I.S.S.N. 1842-9238

The editorial board claims no responsibility concerning the scientific contents of the published papers in this issue.  
The authors take the full responsibility for the contents. No part of this publication may be reproduced, partially or totally,  
without the prior written permission of the publishing board.

*"Henri Coandă" Air Force Academy Publishing House, 160, Mihai Viteazul St., Braşov, ROMÂNIA*  
Phone: +40 268 423421, e-mail: editura@afahc.ro

## CONTENTS

---

### MILITARY SCIENCES

---

Vasile PRISACARIU, Cătălin CIOACĂ, Mircea BOȘCOIANU <b>CONSIDERATION REGARDING OF THE AIRCRAFT INNOVATIVE CONCEPT.....</b>	<b>5</b>
Dinu PĂDURARIU, Nicolae CREȚU <b>THE ROLE OF HELICOPTERS TO MAINTAIN MARITIME SECURITY IN THE BLACK SEA REGION .....</b>	<b>13</b>
Dănuț BĂLOS, Ionică CÎRCIU, Oliver CIUICĂ, Eduard MIHAI <b>THEORETICAL CONSIDERATIONS REGARDING ACAS (AIRBORNE COLLISION AVOIDANCE SYSTEMS) .....</b>	<b>21</b>
Vasile PRISACARIU <b>ANALYSIS OF UAVs FLIGHT CHARACTERISTICS .....</b>	<b>29</b>
Cosmina-Oana ROMAN, Mihai ALEXANDRESCU <b>PROFESSIONALIZATION OF CIMIC STRUCTURE IN THE AIR FORCE .....</b>	<b>37</b>

---

### TECHNICAL SCIENCES

---

Róbert SZABOLCSI <b>OPTIMAL PID CONTROLLER BASED AUTOPILOT DESIGN AND SYSTEM MODELLING FOR SMALL UNMANNED AERIAL VEHICLE</b>	<b>43</b>
Mădălina BORCAN, Cornel STANCA, Marian ALEXANDRU <b>AUTOMOTIVE SAFETY AND THE CRUISE CONTROL SYSTEM .....</b>	<b>59</b>
Cătălin MIHAI, Marian PEARSICĂ, Laurian GHERMAN <b>A NOVEL DATA MINING PROCEDURE GENERATING A TYPICAL ELECTRICAL ENERGY DAILY SHAPE BASED ON VALUES FROM SMART METERING .....</b>	<b>65</b>
Larisa MONACU, Titus BĂLAN <b>SDR SYSTEM FOR GNSS SIGNAL PROCESSING .....</b>	<b>77</b>
Cătălina Maria MĂLĂCEA, Dan Nicolae ROBU, Marian ALEXANDRU <b>MOBILITY IN IP NETWORKS USING LISP AND OPENWRT.....</b>	<b>85</b>

---

**MANAGEMENT AND SOCIO-HUMANITIES**

---

Daniela BELU

**GLOBALISATION OF THE ECONOMIC, SOCIAL AND POLITICAL  
REALITY OF THE INDUSTRIAL CULTURES ..... 91**

**BOOK REVIEW**

---

Adrian LESENCIUC

**AMERICAN ART EDUCATION IN THE LIGHT OF GLOCALIST  
APPROACH ..... 99**

## CONSIDERATION REGARDING OF THE AIRCRAFT INNOVATIVE CONCEPT

**Vasile PRISACARIU, Cătălin CIOACĂ, Mircea BOȘCOIANU**

“Henri Coandă” Air Force Academy Brașov, Romania  
(aerosavelli73@yahoo.com, catalin\_cioacă@yahoo.com, boscoianu.mircea@yahoo.com)

DOI: 10.19062/1842-9238.2018.16.3.1

***Abstract:** The development of the aeronautical field has also been phased by a number of innovative projects, some of which have not necessarily led to operational aircraft, and others have been a research base for a number of valid projects that have proven their technological and operating maturity.*

*The article is both an overview of the most important aerodynamic aeronautical concepts and the risks of innovative concepts as well as a presentation of CAD models of aircraft in an innovative concept.*

**Keywords:** innovative concept, flying wing, XFLR5, aerodynamic analysis.

### *Acronyms and symbols*

AESA	Active Electronically Scanned Array	SEAD	Suppression of Enemy Air Defence
ARCA	Romanian Cosmonautics and Aeronautics Association	TRL	Technology Readiness Level
BWB	Blended Wing Body	UCAV	Unmanned Combat Aerial Vehicle
CAD	Computer Aided Design	VTOL	Vertical Take-Off Landing
SAR	Synthetic Aperture Radar	XFLR	XFoil Low Reynolds

## 1. INTRODUCTION

### 1.1. Evolution

The history of aeronautics shows that aircraft have undergone rapid changes in concept, technology and operation. These changes are focused on performance gains for 1900-1939, minimizing manufacturing costs after the Second World War and on environmental impact after the 1990s. According to the literature after the first 60 years, fewer new projects appeared and the configurations derivatives have evolved from previous concepts and models [1, 2]. However, special bibliographical references provide us with a number of notable landmarks for fixed-wing aircraft in innovative concepts from the most diverse classes that have become operational or have remained at the stage of experimental models or prototypes.

In 1965, NASA developed the tilt wing (VTOL) Chance-Vought XC-142 (FIG. 1) for missions in all weather conditions [3]. The Lockheed D-21B (FIG. 2) was designed for strategic reconnaissance missions, powered by a solid-fuel rocket engine with ramjet engines for take-off [4].

Northrop Tacit Blue (FIG. 3) launched in 1978 by the USAF, the Defence Advanced Research Project Agency and Northrop Corp, had its first flight in 1982 (135 flights) demonstrating invisible radar features [5].



**FIG. 1** Chance-Vought/LTV XC-142A



**FIG. 2** Lockheed D-21B



**FIG. 3** Northrop Tacit Blue

### **1.2. The current state of the innovative aeromechanical concepts**

We present in this section concepts and examples of aero mechanically innovative solutions. The diagram in FIG.4 shows innovative concepts according to the life cycle of an aircraft [7].



**FIG. 4** Innovative concept areas

The joined-wing aircraft (FIG. 5) is an innovative concept that joins the main wings at the trailing edge with sweeping forward rear wings. The rear wing or tail is used for pitch control and to support the forward wing. The joined-wing aircraft has some important advantages like lower structural weights and less drag. Further research will be done in order to develop the discoveries [8, 9].

The box wing concept is much appreciated because it has less fuel consumption compared to conventional aircraft. The reduction of induced drag may accomplish the 75 % reduction of CO<sub>2</sub>. The lighter and smart materials, new technologies and alternative fuels will make the aircraft more efficient [10].

The fuel efficiency, greater endurance in the air and the large airborne tanker have determined the US Air Force to be interested in this concept for the refueling of the military jets [9].



**FIG. 5** Joined-wing concept



**FIG. 6** Blended Wing Body Aircraft

The first aircraft model of the combined body (FIG. 6) was made in 1920. In 1988, Boeing made a BWB tailless construction, the most important result being the reduction of aerodynamic interferences. Aerodynamic performance has been optimized with a fuselage that improves overall lift and reduces wing loading. Nowadays, Boeing Phantom Works, NASA and the Air Force Research Laboratory have come together to study the concept of Hybrid or Blended Body. [11, 12, 13].

The Synergys project goal (FIG. 7) was to build an aircraft which can transport their users from a location to another, in less time and at a lesser cost than airliners or automobiles. The aircraft can carry up maximum six people. The innovative technologies used by the aircraft increased the speed range and because of that Synergy is faster than a supercar but slower than an airliner. The wing-becomes-tail configuration provides outstanding stability and control by reducing drag at low speeds. The Synergy Aircraft provides: greatly reduced travel time, true passenger safety, adaptability to hybrid, electric, and other advanced engine technologies, slow landings at tiny airfields [14].



**FIG. 7** The Synergys concept



**FIG. 8** X-45 UCAV



**FIG. 9** D8 concept

The X-45 (FIG. 8) is an unmanned combat air vehicle design by Boeing in order to be used on strike missions like Suppression of Enemy Air Defence (SEAD), electronic warfare and associated operations.

The swept-wing design accomplished the goal of creating a stealthy UCAV. The aircraft has no vertical or canted tail but it has a blended fuselage and a low-mounted wing in W form.

The X-45 is equipped like Active Electronically Scanned Array (AESA), Synthetic Aperture Radar (SAR) and Raytheon radar. The sensors can identify and locate targets in real time. The UCAV can also be controlled from a ground station designed by NASA [15].

The D8 concept (FIG. 9) is a project founded by MIT in 2010 for the NASA Fundamental Aeronautics Program's N+3. The MIT goal was to reduce emissions and noise.

The D8 is a transportation aircraft which can carry up 180 passengers, with a range of 3,000 nautical miles at Mach 0.72, with low fuel flight. The aircraft matches the Boeing 737 class but the D8's wide body provides more lift than the 737, [16, 26].

### **1.3. Romanian innovative concepts**

The IAR-111 (FIG. 10) is a rocket plane created for commercial suborbital spaceflights by The Aeronautics and Cosmonautics Romanian Association (ARCA). The take-off includes high acceleration, followed by a horizontal acceleration, then by a rapid ascension, to the altitude of 48.000 feet. At this altitude the external fuel tank will be dropped. The aircraft capsule can be separated from the fuselage and it's equipped with two rocket propelled parachutes for safety [17].



**FIG. 10** IAR-111 Excelsior



**FIG. 11** Airstrato

An unmanned aircraft designed by ARCA is the Airstrato. The “drone” is powered by using solar cells and internal batteries or using hybrid propulsion with power generator and batteries. The Airstrato can be controlled via satellite or GSM communication. The UAV uses a pneumatically driven catapult which allows to be launched even from ships. The Airstrato (FIG. 11) has a recovery parachute which can be used in case of emergencies. The electric motors that are used to propel the Airstrato can go from zero to full thrust in less than two seconds. The UAV has an on-board transponder that is equipped with GPS and altitude encoder [18].

## **2. ABOUT THE RISKS OF INNOVATIVE TECHNICAL CONCEPTS**

Initiating innovative projects into unconventional solutions can generate completely new models or a natural evolution of previous models; these new concepts obviously can generate a high risk potential compared to existing conventional projects that have matured [21].

According to the literature [22, 23], various techniques for identifying and managing risks in technical projects have been developed, these being defined as the probability that objectives, costs or performance will not be met.

The risk assessment can be viewed through the TRL technique, becoming the standard technique for assessing the technological maturity of a project and fitting their availability to be included in the new aircraft systems.



The overall risk of the project under consideration is inversely proportional to the level of TRL, so risk is reduced as TRL increases; this approach provides an optimal framework for global risk management (FIG. 12).

For the TRL1 - TRL3 interval, the risks are high due to the uncertainties related to the development and integration of new and complex technologies. The successful and tested solution is the encouragement of research projects in universities (where there is a human resource suitable for innovation).

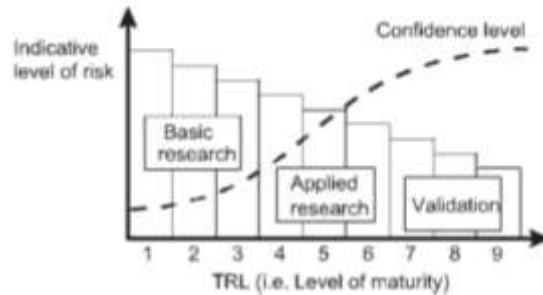

FIG. 12 TRL vs. level of risk

The TRL4 - TRL7 interval, an intermediate level of risk level, translates from an idea to an operational application using modelling and simulation. The technological solution, once validated and demonstrated, reaches the implementation stage (TRL8 - TRL9) where the risks are less perceived due to the existence of an already functional technology. Thus, the problem of financial support is solved at this stage through the realization of public-private partnerships.

Risk characterization is done by assigning a TRL to assess the maturity level of the chosen project, and the admissible risk level of a project by including new technology or new material. It depends both on the failure of the system receiving the new technology and on the inherent failure of technology that is to be inserted. TRLs can be translated as a probability of failure or, more precisely, the probability that the system will not achieve the required goals, time, or performance values.

The innovation process implies a level of risk to be assumed (which can induce side effects) because novelty elements often rely on insufficiently developed concepts, techniques, technologies and materials, or at the limit of scientific understanding [21].

### 3. MODEL CAD OF THE AERODYNAMICS INNOVATIVES CONCEPT

The current state-of-the-art study of aeromechanical solutions for innovative aircraft has led to the CAD models shown in the figures below. Selected aerodynamic solutions can be analysed by multi-criteria or CFD investigations using freeware such as Javafoil, Qblade or XFLR5 [19, 20]. For the geometry we used the CAD tool of the XFLR5 freeware according to the following steps:

- insertion of the airfoils (FIG. 13) with database or drawing;
- geometric editing of the aircraft, with main menu (FIG. 14);
- fuselage, wing, horizontal tail, vertical tail (FIG. 15-17).



2D and 3D freeware tools can be used to build innovative aircraft geometries, such as FreeCad [24] or Google SkechUp [25], which provide sufficient resources and export CAD files for their future use for possible numerical modelling.



**FIG. 19** D21B model CAD



**FIG. 20** Northrop Tacit Blue, model CAD



**FIG. 21** Synergy, model CAD



**FIG. 22** D8, model CAD

For the TRL1 - TRL3 interval, the risks are high due to the uncertainties related to the development and integration of new and complex technologies. The successful and tested solution is the encouragement of research projects in universities (where there is a human resource suitable for innovation).

The CAD configuration with XFLR5 provides possibilities for making 1:1 geometries or reduced scale models for aerodynamic analyses used at aerodynamic concepts or aerodynamic pre-design. XFLR5 provides geometric configuration tools that are accurate enough but with some conceptual limitations on aircraft design, such as a horizontal plane tri-planar plane, asymmetric load lifting surfaces or rotation lifting surfaces (propellers, helicopter rotors). Some of these limitations can be overcome by importing files generated by other CAD tools.

## CONCLUSIONS

Innovative projects are the product of technical creation to the extent that creative processes are tools of convergent thinking focused on solving problems or objectives in part or in full. Projects involving the initiation of innovative solutions provide new multidisciplinary and trans-disciplinary concepts that require significant human, logistical and time consuming resources.

To highlight some optimal aerodynamic features, CFD analysis can be performed taking into account several criteria: flight velocities, range, incidence, aerodynamic mean rope. Free software tools can pave the limits of future CFD analyses powered by resources that provide a higher degree of confidence such as Ansys-Fluent, Floworks/Solid Works.

This type of research, characterized by high risk of failure and high rewards, is encouraged in defence industries that enjoy consistent financial support.

The overcoming of decisional rigidities generated by the unknown ensures the premises of technological domination in a strategic field: aviation.

### **ACKNOWLEDGMENT**

This article was produced with the support of the “Henri Coandă” Air Force Academy and the documentation of the complex project, acronym MultiMonD2, code PNIII-P1-1.2-PCDDI-2017-0637, contract 33PCCDI / 2018 funded by UEFISCDI.

### **REFERENCES**

- [1] Murman, E. M., Walton, M., and Rebentisch, E., Challenges in the better, faster, cheaper era of aeronautical design, engineering and manufacturing. The Lean Aerospace Initiative Report, Series RPOO-02, Center for Technology, Policy, and Industrial Development, Massachusetts Institute of Technology, MA, September 2000;
- [2] Kroo, I. Innovations in Aeronautics. AIAA Dryden Lecture, 42nd AIAA Aerospace Sciences Meeting, 5–8 January 2004, Reno, NV, AIAA paper 2004-0001, pp. 1–11;
- [3] [http://upload.wikimedia.org/wikipedia/commons/b/b5/Ling-Temco-Vought\\_XC-142A.jpg](http://upload.wikimedia.org/wikipedia/commons/b/b5/Ling-Temco-Vought_XC-142A.jpg);
- [4] <http://www.wvi.com/~sr71webmaster/d21~1.htm>, accessed at 14.10.2018;
- [5] Grier P, The (Tacit) Blue Whale, Airforce Magazine, august 1996, available at <http://www.airforcemag.com/MagazineArchive/Documents/1996/August%201996/0896tacit.pdf>;
- [6] Prisacariu, V. Boşcoianu, M. Luchian, A., Innovative solutions and UAS limits, Review of the Air Force Academy No 2 (26) 2014, 51-58 p;
- [7] Harijono Djojodihardjo , Kim Ern Foong, Conceptual Design and Aerodynamic Study of Joined-Wing Business Jet Aircraft, Department of Aerospace Engineering, Faculty of Engineering, Universiti Putra Malaysia, 16 p;
- [8] <http://orbitalvector.com/Aircraft/Box%20Wing%20Jets/BOX%20WING%20JETS.html>;
- [9] Schiktanz D., Scholz D., Box wing fundamentals – An aircraft design perspective , Hamburg University of Applied Sciences, 15 p;
- [10] Smith H., Fielding J.P. , New Concepts for Environmentally Friendly Aircraft, Cranfield University UK, 24p;
- [11] Shilpa Isabella D’souza, An Analysis of the Developments in Blended Wing Body Aircraft for Sustainable Aviation, University of Toronto Institute for Aerospace Studies, 11 p;
- [12] Liebeck, R. H., Page, M. A., Rawdon, B. K., Scott, P. W., and Wright, R. A., “Concepts for Advanced Subsonic Transports,” NASA CR 4624, Sept. 1994. 3 Lieb;
- [13] <https://www.aero-mag.com/box-tail-wing-developments-synergy-aircraft/>, accessed at 15.10.2018;
- [14] <http://www.airforce-technology.com/projects/x-45-ucav/>, accessed at 15.10.2018;
- [15] Drela M., Development of the D8 Transport Configuration, MIT Aeronautics and Astronautics 29th AIAA Applied Aerodynamics Conference 30 Jun 11;
- [16] <http://www.arcaspace.com/en/iar111.htm>, accessed at 14.10.2018;
- [17] <http://www.airstrato.com/en/explorer.html>, accessed at 15.10.2018;
- [18] Hepperle M., Javafoil user’s guide, 2014, p24, available <http://www.mh-aerotoools.de/airfoils/java/JavaFoil%20Users%20Guide.pdf>;
- [19] Drela M., Yungren H., Guidelines for XFLR5 v6.03 (Analysis of foils and wings operating at low Reynolds numbers), 2011, available at <http://sourceforge.net/projects/xflr5/files>;
- [20] Young T.M., Aircraft design innovation: creating an environment for creativity, 2007, Proc. ImechE Vol. 221 Part G: J. Aerospace Engineering, DOI: 10.1243/09544100JAERO129;
- [21] Chapman, C. and Ward, S. Project risk management: processes, techniques and insights, 1997 (John Wiley & Sons, Chichester, UK);
- [22] Crossland, R. J., Sims Williams, J., and McMahon, C. The practical application of design risk assessment models. J. EngngManufact., 2003, 217, 227–234;
- [23] <https://sourceforge.net/projects/free-cad/>, accessed at 16.09.2018;
- [24] <https://www.sketchup.com/download>, accessed at 16.09.2018;
- [25] Drela M., Development of the D8 Transport Configuration, Paper 2011-3970, 29th AIAA Applied Aerodynamics Conference, 27–30 June 2011, Honolulu, HI.

## THE ROLE OF HELICOPTERS TO MAINTAIN MARITIME SECURITY IN THE BLACK SEA REGION

Dinu PĂDURARIU, Nicolae CREȚU

National Defense University "Carol I" Bucharest, Romania  
(dinupadurariu@yahoo.com, shimu\_nae@yahoo.com)

DOI: 10.19062/1842-9238.2018.16.3.2

**Abstract:** The current geopolitical and international security context, characterized by the tendency to change positions of major actors through a diversification of the sources of tension as well as by a significant increase in uncertainty at times, triggered by political, regional, and/or military elements, highlights the dangerous possibility of an almost inevitable future conflict able to restore areas of influence and to establish a balance of forces at a global level. The article analyzes the role of helicopters in maritime security in the Black Sea Region, based on the Euro-Atlantic concepts and the capabilities of the maritime states.

**Keywords:** maritime security, Black Sea Region, helicopters in maritime security operations

### 1. MARITIME SECURITY: STRATEGIES AND CONCEPTS

Before dealing with the specific determinations that maritime security brings to the security concept, we must look at the proximal genus.

If we look at „security” in The Explanatory Dictionary of the Romanian Language, we will find the following definition „being sheltered from any danger, the sense of confidence and tranquility that one gives to the absence of any danger; protection, defense”. In the case of animated curiosity we can also consult the Dictionary of Romanian Literary Modern Languages (DLRLC), published half a century before. First, we would find a very similar definition: "being sheltered from any danger; the sense of security that someone gives to the absence of any danger; (in particular) the safety of the borders and institutions of a state”. But even more interesting than semantic explanations are the contextual explanations that the authors of the two dictionaries feel compelled to give. So the more recently mentioned dictionary provides us with the definition of collective security ("the relations between states, created by treaty measures of common defense against aggression") and of social security ("all legal regulations for social security status at all layers like persons, social group or total population, as well as for the protection of disadvantaged or marginalized people "). Finally, the dictionary topic caught our attention by pointing at the existence of an outdated meaning, namely "a repressive state organ that has the task of defending by any means the communist system of Romania". Of course, lexicographic writing in communist Romania, as interested in either collective or social security, and in any case could not associate the adjective "repressive" with any state organ whatsoever. Instead, the DLRLC uses quotes from *Scânteia* to illustrate the meanings of occupational safety and security, as well as the syntax of the Security Council. And the attention of writers at the middle of the century, turned to the state organ "who oversees the internal security of the state and of the citizens' lives and defends the public goods against the scams of class enemies", giving a completely utopian definition.

From the comparison of the two explanations offered by dictionaries, coming from different regimes, we believe that it was clear that lexicography even bears the consequences of ideology. If this is how words function, and within such a short period, the differences are even greater over longer periods of time and in the sphere of notional content. That is why we will return to the origins of the term and we will strive to outline a brief etymological evolution. The most distant language in which the word of security is to be sought is Latin. The word *securitas* is the noun which expresses the state of carelessness, of inner peace. From Latin, the term went into French by borrowing, meaning a sense of security. Only in French at the second hand and with a meaningful change the term has spread to several European languages, including Romanian. The diachronic evolution of the word was not solely responsible for its semantic diversity. Within each language a difference can be made between at least two levels of use: the common one, used by the two dictionaries mentioned above and a specialized niche according to the fact that security does not mean as much protection and defensive strategy as it stands for equilibrium, prevention, deterrence, intimidation. With this we have reached the semantic area that interests us. The use of the term security with this latter meaning to name the concerns of contemporary states denotes not a random linguistic preference but a specific conception. To clarify this idea, we will consider it in contrast with an old concept used socialist Romania: that of collective defense. By the very use of the noun 'defense', one can easily tell that there is a radically different philosophy according to which all efforts are channeled in a defensive direction. So we can talk about a passive attitude. While, on the contrary, the use of the term security with its meaning of balance implies the assumption of an ambivalent participation on the geopolitical scene. The state that seeks security not only reacts to the movements of the other players, but also takes advantage of the opportunities that have emerged and acts to correct the imbalances that would jeopardize it. To defend yourself is to look only at your own borders. To pursue security means to look beyond borders, to the neighbors' neighbors, to the balance between the great actors, to watch all the opportunities to propagate stability.

But how does maritime security differ as a species from the general security concept as a proximal genre. There is an abundant literature that has highlighted the specificity of the seas and oceans as a strategic space due to the technical, economic, geographical features that are inherent in this environment. In political discourse, the notion has gained an increased frequency over the last three decades, but it is rather intuitive that the concepts considered are more or less different.

Just like other international approaches, maritime security is a term that draws attention to new challenges and, together with other security-related tasks, has the role of protecting against the current risks and threats that are in the process of development to the future. Of course, when we talk about maritime security, we also need to indicate the type of threat that prevails at sea at some point.

Although at present, the EU does not have a permanent naval component such as NATO's naval force, the European Maritime Security Strategy (SEES) for the global maritime domain was adopted by the European Council in June 2014, implying improving the way the EU anticipates and responds to the challenges can affect people, activities or infrastructures in the EU.

The strategy addresses maritime security as an international civil-military activity aimed at reducing risks and countering illegal or threatening maritime activities, law enforcement, protecting the EU's maritime interests in the world.

This strategy has been complemented by an action plan to boost its implementation. All stakeholders in the field of maritime security in the EU - from all sectors and Member States - are invited to participate directly in a cooperation framework.

In this endeavor to redefine marine security concepts and strategy, in June 2018 the SUESM Action Plan was revised, the new Action Plan having a horizontal (A) spanning 5 key areas, devoted to cross-cutting issues and a new regional part (B) in which the EU aims to address global challenges through regional solutions for European non-violent sites (in European sea basins such as the Mediterranean Sea and the Black Sea) and internationally (Guinea Bay , Horn of Africa, the Red Sea or Southeast Asia).

We can therefore speak of a new approach to maritime security, which focuses on 5 key/domains that aim at defining maritime security in positive terms and in terms of economic development through the use of the sea's advantage. And it is not just a conceptual approach to the phenomenon, but going further it has to become a response to the way in which these threats are countered and how the relations between the states involved are affected. These areas are: international cooperation, maritime surveillance, capability development, research and innovation, awareness and management of risks, education and training.

Recognizing the importance of enhancing stability at sea, both NATO and the US increasingly use the term maritime security operations to describe maritime operations in which international and national laws are respected, in which the right to free navigation is assured and citizens, infrastructure and maritime resources are protected.

The concept of joint maritime security describes an ideal form of cooperation between all relevant actors in the maritime sector. In this ideal form, all stakeholders identify threats that are existential and what should be done to counteract them by developing a common understanding of repertoire and creating instruments to promote maritime security.

Security co-operation has been understood as a form of political alliance largely characterized by the absence of war, the peaceful resolution of conflicts and a growing sense of mutual trust and the development of a collective identity.

The notion of alliances integrates into the current security thinking and develops this concept further claiming that an adequate understanding of regional stability must go beyond the traditional understanding of war and how distinct threats are identified while the organization is reacting collectively.

Beyond the theoretical milestones outlined above, which can be subsumed into a unitary doctrinal vision, we must take into account a variety of academic visions, of course, that it is justified to review them and discuss each one, for in fact, the discussion should focus not on the objective specificity of the maritime environment, but on the plurality of theoretical approaches of the concept. The idea is not new and has been circulated in the Romanian academic environment, but the stake is not to explore and highlight the diversity of approaches within the Western academic communities, but to put forward Western doctrines with the doctrines of other actors on the world stage. To miss the significance of the concept of maritime security for Russia, for example, means failing to achieve our own Black Sea security goals, if we are referring to NATO member countries.

## **2. THE USE OF HELICOPTERS IN MAINTAINING MARITIME SECURITY**

When talking about the place and role of helicopters in operations, in general, we must keep in mind that each helicopter type or variant has distinct characteristics that determine the primary role in which it can be used.

It consists in the fact that most helicopters can carry out a wide variety of missions and have general characteristics that recommend them to be used both on the frigates to carry out their missions as well as on the shore as required by the situation. In an appropriate configuration, so far, he can carry out air and medical evacuation missions, day and night, search and rescue missions at sea, day and limited at night, as well as naval surveillance and research missions.

Another relevant feature of the naval helicopters on board the frigates is the ability to react quickly in the marine environment. This is evidenced by the fact that frigates with helicopters on board are able to react in a short time to unforeseen situations and to respond adequately and timely to crisis situations. Preparing for action goes hand in hand with many non-combatant activities such as strength exertion, logistical and medical support, etc. Also, through the experience acquired and the necessary capacities to resolve conflicts, frigates can offer a wide range of services to support operations from peacetime in a favorable environment to covering the entire spectrum of conflicts in the environment hostile.

Missions to combat piracy by helicopters involve both discoveries by research and intervention at ships suspected of piracy. Next, for a better understanding of the subject, we will refer to the use of helicopters only in the Black Sea area.

The character of "sealed", the small area (436,000 km<sup>2</sup>) and the endowment of defense structures (civil and military) made piracy so far not a problem in the Black Sea region.

Helicopter missions can also be adapted to the protection of commercial ship convoys by detecting small threat ships and combating them if necessary especially in anti-piracy operations.

Technique involved in carrying out these operations consists of helicopters embarked on surveillance frigates and ground based helicopters. These missions have a wide range of tasks such as territorial waters monitoring, SAR, internal security (e.g. anti-drug operations). These missions can also be extended to international waters, especially those designed to prevent drug trafficking, where helicopters can be involved in tracking and catching fast-track boats. Moreover helicopters support Special Forces in amphibious operations through tactical transport, information provision, supports in combat and antiterrorism fight.

The volume of maritime trade has increased fourfold worldwide since 1965, only in the Black Sea, sailing around 100 commercial vessels a day. Globalization, which has made it easier for cross-border traffic and the information revolution, highlights the fact that the oceans and seas of the world have become an increasingly accessible environment for criminal activities and potentially hostile actions. These to enroll in a broad spectrum like illegal immigration, trafficking in human beings, weapons, drugs and piracy to terrorism and the proliferation of weapons of mass destruction and their means of transport to their destination.

MSO Maritime Surveillance Operations are under the responsibility of the Coast Guard, being carried out by the Navy with the support of the border police and even the Gendarmerie in some situations but in time of peace, embarked helicopter frigates can be used to monitor the naval situation and control maritime traffic in the territorial sea, the contiguous area and the exclusive economic zone of Romania, to support forces specializing in the fight against maritime pollution, smuggling and illicit arms transport and drugs, as well as national and international search-rescue efforts or humanitarian aid.

They also have an important role to play by participating in bilateral and multinational exercises within NATO or the coalition to which our country is a party.



In addition to these actions, they can detect, warn and control ships and boats suspected of terrorist activities or cross-border organized crime (illegal trafficking in human beings, arms and ammunition, drugs, prohibited material) on the sea.

If required, the frigates take part in naval actions against drug trafficking in support of NATO or Partner country specialized agencies to detect, monitor, prevent, produce, transport and distribute illegal drugs. Allied naval forces can be effectively deployed in detecting and monitoring drug trafficking, as well as those involved, until specialized agencies intervene in their area of responsibility. Against maritime terrorism, they can participate in offensive (counter-terrorism) and defensive (anti-terrorism) missions, and by taking effective protection measures to reduce the success of any terrorist attack against ships.

In the case of a request to participate in national or international search-rescue or humanitarian aid actions, the frigates have the capabilities to carry out search, rescue, and medical assistance to shipwrecked persons, capacities greatly multiplied by the presence of the embarked helicopter. The management of search and rescue operations at sea in the maritime area of responsibility is under national responsibility, with the participation of border police, military and civilian ships or aircrafts. All forces involved in these SAR operations apply the IMO and NATO procedures.

With regard to the use of helicopters for the areas of the EU Strategic Action Plan, they can be used in MSO maritime surveillance missions to monitor the naval situation and control maritime traffic.

### **3. THE PRESENCE OF HELICOPTERS IN MARITIME SECURITY OPERATIONS AT THE BLACK SEA**

We will continue to review the capabilities of the three NATO states at the Black Sea.

The naval forces of the Republic of Bulgaria it has three Corvettes of Soviet origin Tarantan class, a Soviet frigate of the Koni class and three Belgian frigates Wielingen. At present, the Bulgarian navy has two Eurocopter AS565 Panther helicopters that it can use in sea operations at the Chayka Air Base, without any boat.

The Romanian naval forces are equipped with a frigate Mărășești class, two frigates of British production class 22 Broadsword and 4 corvettes of Romanian production Tetal class. It also has three IAR 330 PUMA Naval helicopters that can be operated both by the frigate board and on land from the Tuzla aerodrome.



IAR 330 PUMA Naval



FRIGATE Mărășești

Turkish naval forces have 16 frigates, 10 corvettes, 12 submarines and 37 helicopters (12xAugusta-Bell AB-212 ASW Italian, 25xSikorsky S-70B-28 American Seahawk) which can be operated from several platforms both sea on land.



Augusta-Bell AB-212



FRIGATE G-class

The Russian Black Sea Fleet consists of a wide range of ships, of which we remind you of the most important ones: Moskva cruiser Slava class, destroyer Smetlivyy class Kashin (the only ones of its kind in the Black Sea), 5 frigates (2x Krivak class and 3x class Amiral Grigorovici), 8 corvettes (3x class Grisha, 1x Buyan-M, 2xDergach, 2xNanuchka-III). In support of them are also used 20 helicopters Kamov Ka-27 and Mil-Mi 14.



Kamov Ka-27



Russian CRUISER Moskva

Two types of approaches are possible when assessing the performance of the four states. First, considering that since the end of the Second World War there have been no armed conflicts in the sea basin, as no piracy cases have occurred in the last seven decades it can be considered that endowment is beyond the necessity of such threats.

The prompt response would be that neither piracy nor armed conflicts are imminent attacks on maritime security at the Black Sea, precisely because of the discouraging role that these capabilities have. At the opposite end, political decision makers could be criticized for having too little effect, insufficient endowment if it is to compare the French, Italian and United Kingdom Naval Forces.

The replica has to come in two levels: firstly, the character of the sea closed and the reduced surface has the effect of amplifying the effective army efficiency mentioned above, whose effectiveness would be diffused in sea open conditions and large stretches of water (like the Mediterranean Sea). Secondly, an increase in endowments and flocks may easily have the unwanted effect of an arms race. The riparian states felt directly threatened by each other.

If we are to discuss threats of high probability, such as illegal migration and poaching, helicopters prove to be rather fewer. The procedural roles are indisputable. But they can rather be a tactical response, not a strategic solution. The tightening of regulations on the ownership and use of craft along with the increase of police controls on land and in the coastal area can significantly limit the phenomenon of poaching while the threats associated with the migratory phenomenon can be diminished and then eliminated through a wide range of diplomatic, financial or military actions.

## CONCLUSIONS

By considering the most important military and political events of the last century and a half we can come to the conclusion that the Black Sea plays a role for its maritime states, their ability to shelter the threats that concern them and that diplomatic and politico-military actions in area may have deep recesses outside the actual settlement. In other words, national and transnational interests that intertwine lead to a difficult geostrategic dynamics around the ancient Pontus Euxinus. That is why we need to have a flexible look at the concept of the Black Sea region. Of course, all six Black Sea exit countries are part of the region but the interests of their neighbors, allies and even their competitors play a decisive role in long-term regional development.

Helicopters, and especially naval helicopters operated from ships, prove their usefulness, particularly in complex situations, during operations at sea, when the other on-board means are limited technically or tactically. Their multiple use resources (autonomy, range of action) make them indispensable in ensuring the consistency of ship systems, whose performance increases considerably.

Also the protection of helicopter navigation can be accomplished by distant or near escorting, naval cooperation and airborne air traffic controller.

To the extent that it solves the stringent problems of the Navy in the 21st century, the use of helicopters to ensure the safety of security also creates new challenges and new needs. Synergic operation of the helicopter-ship binomial remains to be improved in such a way that the two components (maritime-to-air) operate in a complementary manner. In this direction the technicians and strategists in the doctrine are expected to compete. It is a good collaboration of military research that can generate the optimal formula of the airborne couple.

## REFERENCES

- [1] Academia Română, Institutul de Lingvistică „Iorgu Iordan” (2009) *Dicționarul explicativ al limbii române*, București: Editura Univers Enciclopedic;
- [2] Andreea Tobias, Pescador turcesc, prins la braconaj în Marea Neagră. Polițiștii au tras focuri de armă, Mediafax, 2018. Available on: <https://www.mediafax.ro/social/pescador-turcesc-prins-la-braconaj-in-marea-neagra-politistii-au-tras-focuri-de-arma-17126175> (accessed at September 4, 2018);
- [3] European Commission, European Union Maritime Security Strategy. Responding Together To Global Challenges. A guide for stakeholders. Available on: <https://ec.europa.eu/maritimeaffairs/policy/maritime-security.ro> (accessed at September 12, 2018);

- [4] Victor Cozmei, INFOGRAFIC Rusia vs. NATO la Marea Neagra. HotNews. Available on: <http://www.hotnews.ro/stiri-esential-20847917-infografic-rusia-N.A.T.O.-marea-neagra-cum-arata-lota-romaniei-turciei-bulgariei-comparatie-fora-militara-rusiei-submarinele-fregatele-crucisatoarele-din-dotarea-celor-patru-armate.htm> (accessed at August 20, 2018);
- [5] NATO, NATO's maritime activities. Available on: [https://www.nato.int/cps/ic/natohq/topics\\_70759.htm](https://www.nato.int/cps/ic/natohq/topics_70759.htm) (accessed at October 23, 2018).

## THEORETICAL CONSIDERATIONS REGARDING THE ACAS (AIRBORNE COLLISION AVOIDANCE SYSTEMS)

**Dănuț BĂLOS, Ionică CÎRCIU, Oliver CIUCĂ, Eduard MIHAI**

“Henri Coandă” Air Force Academy, Braşov, Romania  
(danut.balos@gmail.com, circuionica@yahoo.co.uk, oliverciuca@yahoo.com,  
mishued2004@gmail.com)

DOI: 10.19062/1842-9238.2018.16.3.3

***Abstract:** The Airborne Collision Avoidance System (ACAS) represents the latest solution in worldwide aviation with respect to the detection and management of air traffic conflicts between aircraft. The article intends to offer a quick review of the ACAS system in what concerns its components, functioning and operation.*

***Keywords:** airborne collision, transponder, ACAS, TCAS.*

### ***Symbols and acronyms***

ACAS	Airborne Collision Avoidance System	BCAS	Beacon Collision Avoidance System
TCAS	Traffic Alert and Collision Avoidance System	TA	Traffic Advisory
CPA	Closest Point of Approach	SL	Sensitivity Level
RA	Resolution Advisory	PWI	Proximity Warning Indicator
SSR	Secondary Surveillance Radar	ATM	Airport Terminal Management
ATC	Air Traffic Control	ADS-B	Automatic Dependent Surveillance Broadcast
FMS	Flight Management System		

## 1. THEORETICAL GUIDELINES

### **1.1. Introduction**

The ACAS represents the latest accepted solution in worldwide aviation regarding the detection and the management of air conflicts between aircraft. The main element of the ACAS system is made of the implementation on board of the TCAS II versions 7 and 7.1 and the pilot procedures regarding the use of these pieces of equipment. It represents the last barrier used to alert the staff on the imminent danger of collision and on the manner of avoiding it, being complementary to the safety systems on the ground implemented in the ATM [1, 2].

TCAS is the commercial brand name for the ACAS. The TCAS is a system based on the communication between two or more aircraft, which are in a traffic conflict, with the help of transponders. We have to mention that the system cannot provide any protection against aircraft which have no integrated transponder. Compared to TCAS I, which only provides warnings when an aircraft is nearby, helping the pilot to reach a better visualization of the danger, TCAS II offers traffic guidance and recommends avoiding vertical maneuvers.

TCAS II monitors the air space around the aircraft, questioning the aircraft transponders situated in its working perimeter.

The data collected from the interrogated aircraft transponders provide the system with the following information: the distance between the two or more aircraft involved, the relative direction, the altitude and the vertical velocity of the interrogated aircraft and the approach speed of the interrogated aircraft. If TCAS II estimates that the space in which the aircraft can consider that its safety has been violated, it will provide traffic advisory TA in order to let the crew know that there is an aircraft nearby. If the aircraft continues the approach, the TCAS II will radiate a RA radiation in order to obtain or maintain a safe distance from the unknown aircraft.

The Airborne Collision Avoidance System (ACAS II) with hybrid surveillance option, certificated by EASA in 2011, supposes the use of an active surveillance combination, meaning the active interrogation (module S) of the aircraft's transponders from the surroundings and passive surveillance, for instance, the use of the ADS-B position and of the altitude data (extended squitter), to the updated monitoring of the ACAS II [1].

The aircrafts equipped with TCAS II will communicate and will solve the traffic problem by using a Mode S transponder. The coordination between them assures the successful avoidance of a collision. The crew must immediately and smoothly follow the resolution advisory (RA). Because of the fact the maneuvers are coordinated by TCAS II, the crew must not execute maneuvers in the opposite direction of the one indicated by TCAS II. TCAS II can monitor 45 aircraft; it can show up to 30 aircraft and can find resolution advisory (RA) for 3 aircraft at the same time.

### **1.2. History and evolution**

The interest in the developing a collision avoidance system, dates back to 1956 when a collision between two commercial airplanes took place over the Grand Canyon in The United States of America. Both the air companies and the air authorities have realized the importance of implementing such a system which was for the first time initiated and tested by Dr. John S. Morrel. The contemporary collision avoidance system is based on his concept. Before CAS (Collision Avoidance System) systems there was the Proximity Warning Indicator (PWI). For 2 decades a variety of collision avoidance systems were explored, many of them with promising results in testing. Researchers came to the conclusion that the common air operations would have generated a wide range of false alarms, especially in the airdromes areas. Such tests took place until 1974, when the Federal Aeronautic Authority chose to concentrate its efforts and resources on the BCAS System (Beacon Collision Avoidance System) based on the transponder. In 1978 a second collision took place between a light aircraft and an airliner near the city of San Diego, event which led to the expansion of the BCAS System. In 1981 its name was changed into TCAS (Traffic Alert and Collision Avoidance System) [2].

Starting with the 80s, the ICAO (International Civil Aviation Organisation) developed along with the development of the TCAS system the standards for the ACAS (Airborne Collision Avoidance Systems), conceived to function independently and autonomously both in relation to the navigation equipment of the aircraft and to ground systems used to furnish traffic air services. The first mandatory implementation of an collision avoidance system, TCAS II, was required to the flights in the United States air space starting with the 30<sup>th</sup> of December 1993. In 1995, Eurocontrol approved an implementation politics and a mandatory equipment program regarding the use of the ACAS II in Europe. This latter stipulated that starting with the 1<sup>st</sup> of January 2000 all civil fixed-wing and turbine engine aircraft having a takeoff mass over 15,000 kg, or a maximum approved passengers places configuration bigger than 30, will be compelled to equip themselves with ACAS II and starting with the 1<sup>st</sup> of January 2005 all civil fixed-wing and turbine engine aircraft which have a takeoff mass over 5,700 kg or a maximum approved passengers places configuration bigger than 19, will be compelled to be equipped with ACAS II [1, 2, 3, 4].

### 1.3. Future trends in research

The emergence of UAVs in modern air space has generated the necessity of the use of TCAS in order to reduce the risk of collision between air vectors in different phases of the flight. According to specialist references, UAS capabilities can be multiplied by having on board such a system. Precise information on the airspace in which a UAV will perform can reveal the trajectory characteristics and specifications of any TCAS on all the other aircraft in the area [5, 6, 9].

## 2. TCAS COMPONENTS

Globally, there are several constructive types of aircraft collision detection and alert systems available on board aircraft. Regardless of the manufacturer, the main components, the operating principle and the generated alerts are the same.

### 2.1. The computer of the TCAS

Also called the processor of the TCAS unit / computer unit, it provides: airspace surveillance; detecting and tracking the intruder aircraft; tracking the altitude of your own aircraft; detection of threats; determining and selecting the direction of the avoidance maneuver RA; generating traffic alerts. The processor uses barometric altitude data, altimeter radar width, and a discreet spectrum of inputs on the state and controls of its own aircraft to control the logical process for determining the protection zone, see FIG.1.

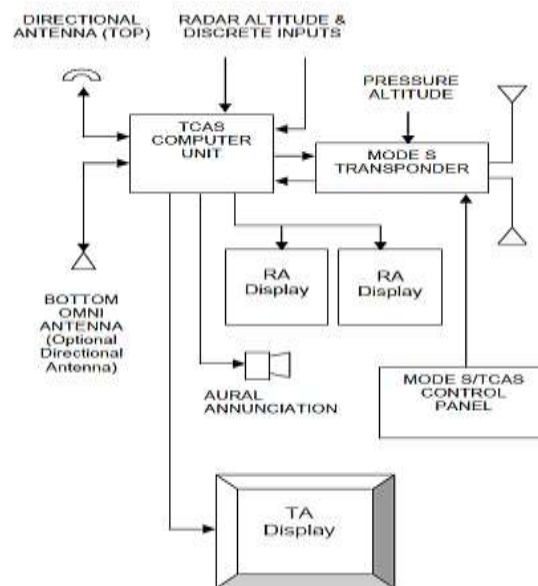

FIG. 1 System block diagram of TCAS, [1].

Position signals, speeds, direction of movement for each aircraft are taken over by process chain: the Antenna - GPS Receiver - Adapter - applied to the adder, where the errors at a given point in relation to the barometric altimeter can be very consistent, depending on the overflow area.

Traffic avoidance actions are taken based on these aircraft input parameters. The generated solution will have the least impact on the aircraft's trajectory. If the intruder aircraft is equipped with TCAS II, the avoidance action will be coordinated with the intruder aircraft.

### 2.2. Mode S Transponder

This is an essential component for having an operational TCAS II.

If this component fails, the performance monitoring system will detect this and switch the TCAS to "stand-by" mode. The Mode S transponder is especially designed for the use along with the ground Secondary Surveillance Radar (SSR). It was later integrated into the "air to air" data exchange between aircraft equipped with conflict detection and resolution systems, generating together avoidance solutions.

### **2.3. The Mode S/TCAS Control Panel**

A single control unit is provided for the operation of these two types of interdependent equipment. It provides four control positions:

- Stand-by: the TCAS processor and the Mode S transponder are power supply, but there will be no CPC queries and the transponder will only respond to discrete queries;
- Transponder: The Mode S transponder is fully operational and will respond to queries of ground stations and other TCAS systems;
- TA Only: The Mode S transponder is fully operational, the TCAS will operate normally, it will provide interrogations and Traffic Monitoring functions but will only transmit TA alerts, RAs type alerts being restricted;
- TA/RA: Both Mode S transponder and TCAS are fully operational, providing interrogation and monitoring processes. TA and RA alerts will be transmitted. As can be seen from FIG. 2, all TCAS control signals are routed through the Mode S transponder.



**FIG. 2** The Mode S/TCAS control panel, [7]



**FIG. 3** TCAS system antenna, [8]

### **2.4. Antennas**

The antenna system used by the TCAS includes a directional antenna located above the aircraft and an omnidirectional or directional antenna mounted at the bottom of the fuselage. These antennas transmit queries on the 1030 MHz frequency at different quadrant intensities in the four azimuth segments of 90°. The bottom-mounted antenna emits several interrogations at signal intensities lower than the top of the fuselage antenna, see FIG. 3.

The signals are received through the same antenna array at the 1090 MHz frequency and direct these responses to the TCAS processor. Additionally, the Mode S transponder requires the existence of two similarly disposed antennas in the top and bottom of the fuselage through which it receives signals at the frequency of 1030 MHz and responds to the queries on the frequency of 1090 MHz.

### **2.5. Cockpit presentation**

The TCAS' interface with the crew is provided by the presence of two displays in the cockpit: traffic display and RA display. There may be different presentations including merging both displays in one display. Regardless of the mode of presentation, the functions are the same according to accepted and specified standards in DO-185B and ED-143, see FIG. 4.



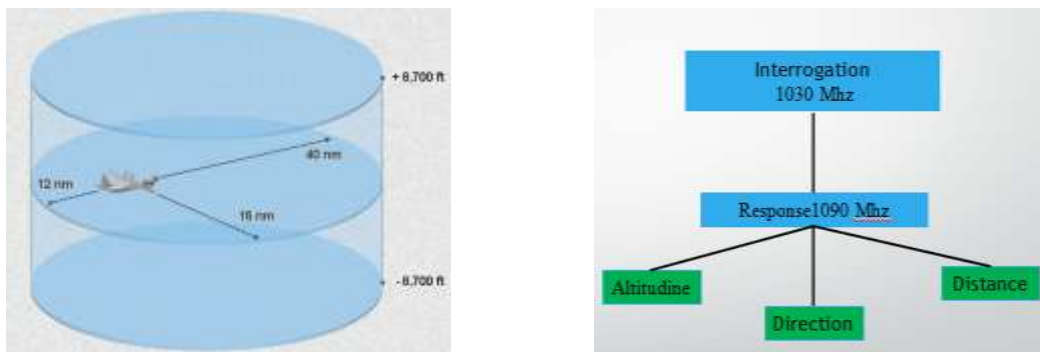

FIG. 4 EFSI and IVSI indicators, [1]

### 3. TCAS FUNCTIONING PRINCIPLE

The TCAS concept involves the use of radar transponder beacons installed on the board of the aircraft operating with the SSR secondary radar of the ATC units. The level of protection provided depends on the type of transponder installed on the target aircraft. It is essential to note that the system does not provide any protection against aircrafts that are not equipped with a transponder on board and are entering the theoretical protection zone provided by the TCAS, see FIG. 5.

The TCAS II system was designed to operate in traffic with a density of 0.3 aircraft / NM<sup>2</sup>, which involves approximately 24 aircraft over a 5NM radius, the most intense traffic volume expected for the next 20 years.



a) TCAS surveillance area

b) TCAS-transponder information flow chart

FIG. 5 TCAS functioning principle

Designed to work independently of aircraft navigation systems or ground surveillance systems, TCAS interrogates the proximity aircraft transponder system and, based on the received response, it calculates the direct distance, flight altitude (when included in the response message) and head relative flight of the aircraft surveyed. From several successive responses, TCAS calculates the Closest Point of Approach (CPA) with the intrusive aircraft by dividing the distance separating the aircraft at the approach rate. This time value is the main trigger parameter for TA / RA alerts. The TCAS II is designed to ensure protection by avoiding collisions at any rate up to 1200 kt and vertical speed of 10,000 fpm.

In order to determine the distance and the altitude, the aircraft identifies itself into a system of Cartesian coordinates using a 3D positions equations:

$$(p_n)_t = [(p_n)_{x,t}; (p_n)_{y,t}; (p_n)_{h,t}]^T \tag{1}$$

And 3D expression of the velocity/speed of the n aircraft

$$(s_n)_t = [(s_n)_{x,t}; (s_n)_{y,t}; (s_n)_{h,t}]^T \quad (2)$$

where the x, y indices represent the horizontal axis of the coordinate axes, the h represents the altitude/height and T is the estimated buffer. The determination of the position of the aircraft is also taken from the Global Positioning System (GPS) satellites to eliminate the errors of determination, see FIG. 6. Due to the quicker microprocessors and the precise real-time data provided by GPS, highly accurate navigation is now possible.

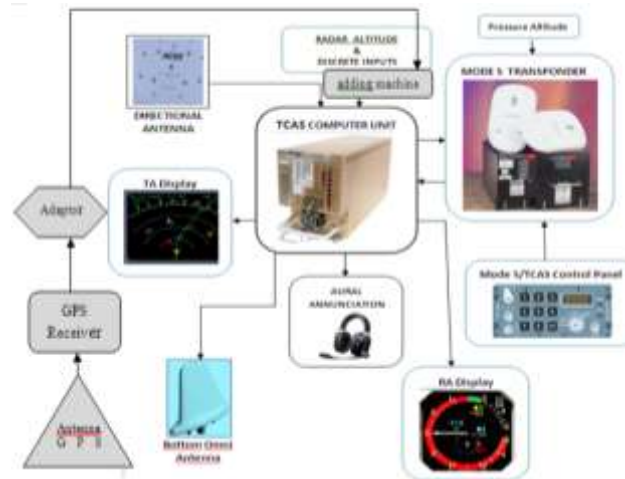

FIG.6 TCAS simplified functional diagram with a GPS module [10].

#### 4. PROPOSED SCENARIO

Most studies on TCAS have considered the analysis of two aircrafts. Thus, TCAS research and development required an expensive cycle of analyses, computational simulations followed by operational tests and evaluations, at an estimated cost of over \$ 600 million in 2005. Even if there are scenarios that took into account the interaction of a UAV- aircraft, TCAS development has not occurred for UAVs. We propose a scenario for analyzing several different types of UAVs with TCAS. Several collision avoidance methods by UAVs have been considered, similar to those studied in the hybrid scenarios aircraft-UAV: LIDAR, electro-optical cameras, electronic detection system, radar, IR cameras, visual observation ground or air based, or a combination of such methods.

A number of issues have been identified so: a) in the low-altitude Class G and uncontrolled airspace where many UAVs fly, TCAS would be unable to detect intruders without TCAS; b) in that scenario there is no capability for a UAV operator to visually be aware on these types of threats; c) numerous studies have shown that the level of safety provided by implementation of TCAS increases, but only if there are no system failures and all the information is perfectly accurate and complete; d) the traffic display information cannot be corroborated by the UAV operator, that means the inability of UAV operator to perform visual acquisition of situational awareness.

The combination of three techniques allows safety to be quantified and a collision avoidance system to be thoroughly evaluated. The first technique is an analysis of all possible failures in the entire collision avoidance operating environment. The output of this technique is a logical tree of failure effects. The second method is to use computer simulation to evaluate TCAS performance in the dynamic environment.

And the third technique is the analysis of TCAS performance on an UAV accomplished through flight testing. These three techniques of safety analysis can be conducted in a similar manner for aircrafts and/or UAVs.

In TCAS studies, data were collected from ground-based radar and were analyzed to find encounters between two aircraft where TCAS would alert the pilots of a potential mid-air collision.

Based on statistical radar data traffic models which reflected the statistical characteristics of the airspace were then developed in which these radar data were collected. Then, millions of data are generated based on the proposed statistical model, which constitute the input data into the TCAS logic model implemented in a Matlab Simulink software tool or similar programs.

The simulation begins by generating situations where there are certain UAV conflicts. The initial conditions and the planned trajectory for each UAV are thus established. After obtaining these data and generating the conflict situation, the data of the trajectories' simulation functions with or without TCAS are provided. It is assumed, as a simplifying condition, that there are no other influences on the planned trajectory other than the TCAS. We get a planned trajectory and a trajectory in which the UAV reacts according to TCAS logic. The position of the aircraft is updated at every step of the simulation, and the future states are influenced by TCAS logic, see FIG. 7.

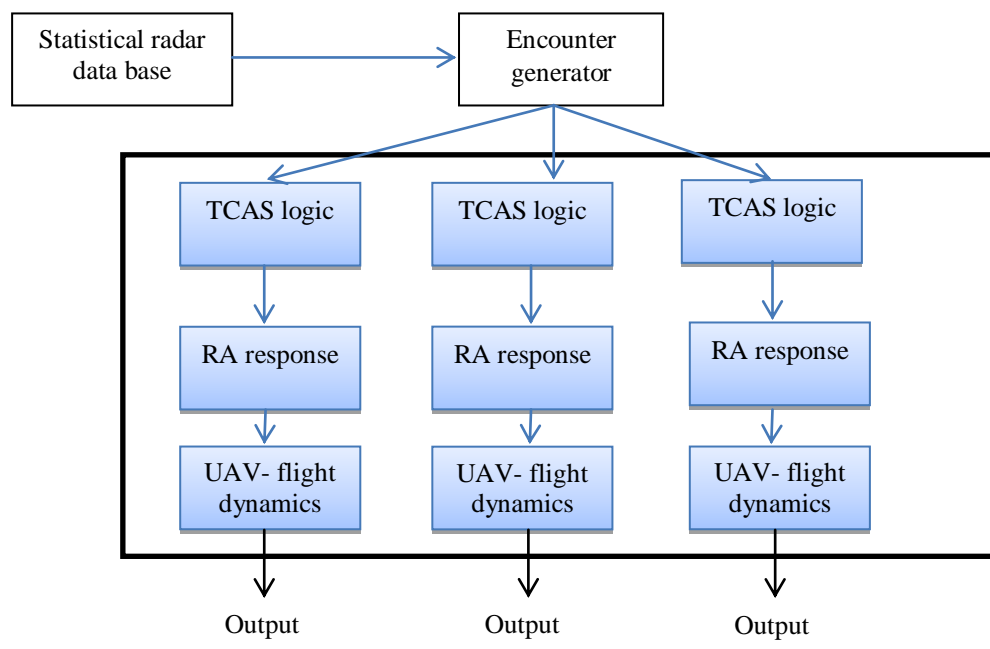

FIG.7 Simulation schematic

## CONCLUSIONS

When TCAS II generates an RA, pilots must: follow the RA even in the case of a contradictory instruction given by the ATC and report as soon as possible using the ICAO standard phrase ("TCAS TC"), if the RA requires a deviation from the authorized trajectory. Reporting RA is very important because: the controller does not know the RA until it is reported by the pilot and determines the moment at which the controller (controller) should stop issuing traffic instructions.

Pilots must also inform controllers of the clear conflict situation as soon as possible. The Module for Training Controllers and Pilots is essential to ensure that the procedures are properly applied and to avoid any interference between the ATC and TCAS II RA instructions.

A pilot will not give priority to the ATC instructions, but must prioritize the reporting of an RA when it has occurred and immediately proceed to execute the RA instructions. ATC Horizontal Avoidance Instructions (before an RA report) will not adversely affect the vertical maneuvers required by TCAS II RA; these are mandatory. The information displayed for air traffic controllers may have a delay of several seconds before providing the ATC separation data - appropriate in the old version - but not optimized for collision avoidance purposes. Controllers should pay attention to periodic training, to avoidance techniques, to action and to the specific phraseology.

### ACKNOWLEDGEMENT

This article was produced with the support of the documentation of the complex project, acronym MultiMonD2, code PNIII-P1-1.2-PCDDI-2017-0637, contract 33PCDDI / 2018 funded by UEFISCDI.

### REFERENCES

- [1] US Department Transportations, *FAA, Introduction to TCAS II version 7.1*, 2011, available at [https://www.faa.gov/documentLibrary/media/Advisory\\_Circular/TCAS%20II%20V7.1%20Intro%20booklet.pdf](https://www.faa.gov/documentLibrary/media/Advisory_Circular/TCAS%20II%20V7.1%20Intro%20booklet.pdf);
- [2] James K. Kuchar and Ann C. Drumm, *The Traffic Alert and Collision Avoidance System*, LINCOLN LABORATORY JOURNAL, vol. 16, no, 2, 2007, p227-296;
- [3] ICAO, *Airborne Collision Avoidance System (ACAS) Manual*, first edition 2006, available at [https://www.icao.int/Meetings/anconf12/Document%20Archive/9863\\_cons\\_en.pdf](https://www.icao.int/Meetings/anconf12/Document%20Archive/9863_cons_en.pdf);
- [4] Eurocontrol, *Unmanned Aircraft Systems – ATM Collision Avoidance Requirements*, edition number 1.3/2010, available at [https://www.eurocontrol.int/sites/default/files/content/documents/nm/safety/ACAS/acas-unmannedaircraftsystemsatmcollisionavoidancerequirements-2010\\_.pdf](https://www.eurocontrol.int/sites/default/files/content/documents/nm/safety/ACAS/acas-unmannedaircraftsystemsatmcollisionavoidancerequirements-2010_.pdf);
- [5] Lawrence Camacho, Cheryl Yuhas, *Civil UAV Capability Assessment*, dec. 2004, available at [https://www.nasa.gov/centers/dryden/pdf/111761main\\_UAV\\_Capabilities\\_Assessment.pdf](https://www.nasa.gov/centers/dryden/pdf/111761main_UAV_Capabilities_Assessment.pdf);
- [6] Prisacariu V., Boşcoianu M., Luchian A., *Innovative solutions and UAS limits*, REVIEW OF THE AIR FORCE ACADEMY, 2(26)/2014, Braşov, Romania, ISSN 1842-9238; e-ISSN 2069-4733, p51-58;
- [7] <https://aviation.stackexchange.com/questions/48050/what-is-mode-b-on-the-transponder>;
- [8] <https://www.ftav.com/product/7514060-902/> accesat la data de 12.09.2018 ;
- [9] Prisacariu V., Cîrciu I., Cioacă C., Boşcoianu M., Luchian A., *Multi aerial system stabilized in altitude for information management*, REVIEW OF THE AIR FORCE ACADEMY, 3(27)/2014, Braşov, Romania, ISSN 1842-9238; e-ISSN 2069-4733, p 89-94;
- [10] Cîrciu I, Luchian A., INTEGRATED AVIONIC SYSTEM SPECIFIC FOR AIR TRAFFIC SAFETY, Review of the Air Force Academy, 3/2014.

## ANALYSIS OF UAVs FLIGHT CHARACTERISTICS

Vasile PRISACARIU

“Henri Coandă” Air Force Academy, Braşov, Romania (aerosavelli73@yahoo.com)

DOI: 10.19062/1842-9238.2018.16.3.4

**Abstract:** *The analysis of flight characteristics of aircraft using freeware tools is used both for educational and research purposes, but especially for computing, construction and manufacturing in the commercial and hobby area. XFLR provides aerodynamic analysis capabilities for non-propulsion aircraft with reasonable results.*

*The article presents 2D and 3D analyzes of the UAV geometry in a classic concept, with a presentation of the numerical differences in flight characteristics for four cases on the profiles used in the wing.*

**Keywords:** *aerodynamic analysis, UAV, XFLR5, flight parameter.*

### Acronyms and symbols

CFD	Computational Fluid Dynamics	AR	Aspect Ratio
LLT	Lifting Line Theory	VLM	Vortex Lattice Method
XFLR	Xfoil Low Reynolds	$\rho$	Air density
$c_b, c_d, c_m, c_y$	Aerodynamic coefficient	$C_L/C_D$	Gliding ratio
AoA, $\alpha$	Angle of incidence		

## 1. INTRODUCTION

Since 2007, XFLR5 has become an open source development project hosted by Sourceforce.net and has been designed exclusively for designing non-propulsion aerodynamic models (without the influence of rotating lifting surfaces/propellers) for which it provides reasonable and consistent results [1].

According to the specialty references [2, 4, 5, 6, 7, 8], the use of XFLR5 is now widely spread both in the educational, research and hobby area. It can perform analyzes for small Reynolds numbers using a series of geometry/comparison Design applications, aerodynamic analysis (2D and 3D) and stability analysis.

The 2D and 3D analysis steps based on three known methods: LLT, VLM and 3D panels are as follows: geometric 2D configuration (aerodynamic profile) by generating NACA profiles or importing a profile from external databases; 2D profile analysis; geometric 3D configuration (fuselage, empennage; wings); 3D analysis on single elements; 3D analysis on complete geometry (considering interferences); stability analysis (with inertial mass values). The results can be viewed graphically or numerically (data export) using three options for the polarities of the analyzed geometry: constant speed, constant lift, constant incidence, [1].

The following is an aerodynamic analysis of a unique geometric configuration (non-propulsion aircraft/gliders) based on four aerodynamic profiles for the main lifting surface (wing), an analysis that wishes to highlight the performance differences of the four analyzed profiles.

## 2. GEOMETRIC CONFIGURATION

The geometric definition of a fixed-wing UAV assumes the same systematic approach as in the case of a aircraft with pilot, that is to say the first aerodynamic concept chosen is implemented according to the main assignment attributed to the air vector, then refined geometric optimization on each main component element (fuselage, wing, empennage).

XFLR5 [1, 4] provides geometric parameterization tools for both rotation (fuselage) and lifting surfaces (wing, empennage). The user interface is intuitive and provides both numeric editing areas (FIG. 1a) and graphics and final geometry information (FIG. 1b).

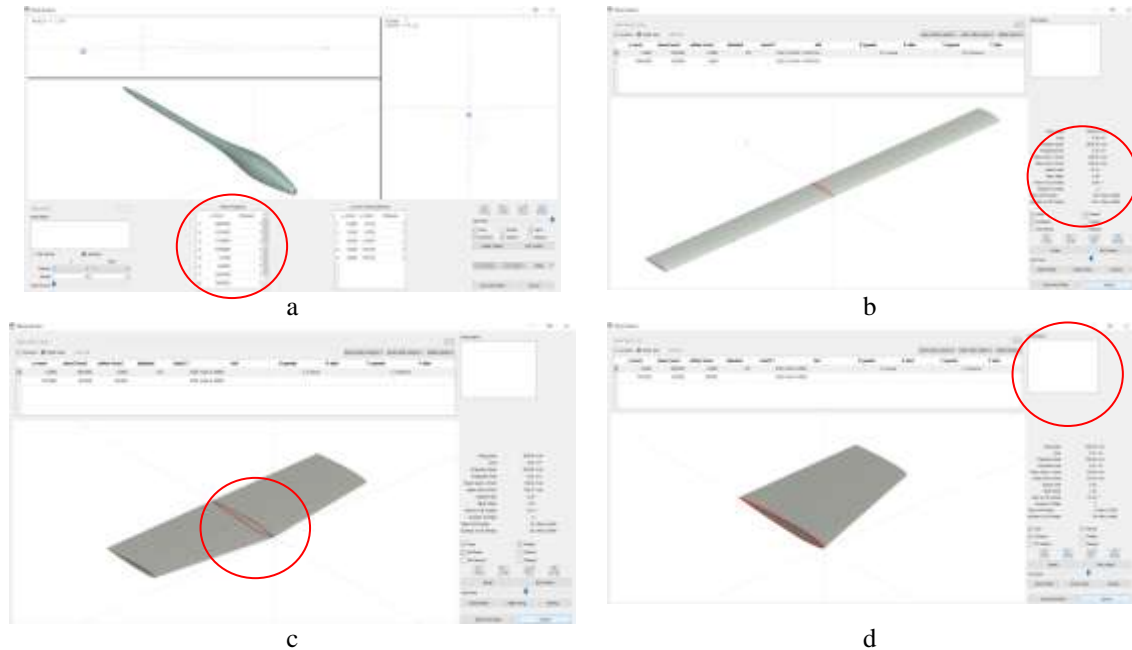

**FIG. 1.** Geometric configuration of UAV, a.fuselage, b. wing, c.horizontal tail, d. vertical tail

The numerical setting of geometric parameters provides in real time 2D and 3D graphical changes (3 views and isometric view) of the parameterized object (FIG. 1c). For additional information, you can use the upper-right editing field of the geometric submenus (FIG. 1d).

## 3. 2D AERODYNAMICS ANALYSIS

2D aerodynamic analyzes were performed on four known aerodynamic profiles, mainly used in tailless (fly wing) aircraft as shown in FIG. 2 and the conditions in Table 1, profiles having different geometric characteristics on the skeleton, thickness and arrow (curvature). [3]

Table 1. Analysis conditions

Parameter	Value	Parameter	Value
AoA range	-5..15°	Nr. Reynolds Re	684000
Air density $\rho$	1,225 kg/m <sup>3</sup>	Cinematic viscosity	1,46x10 <sup>-5</sup> m <sup>2</sup> /s
Iterations	100	Viscosity / boundary layer	activ / activ
Chord	1 m	Analysis type	constant speed

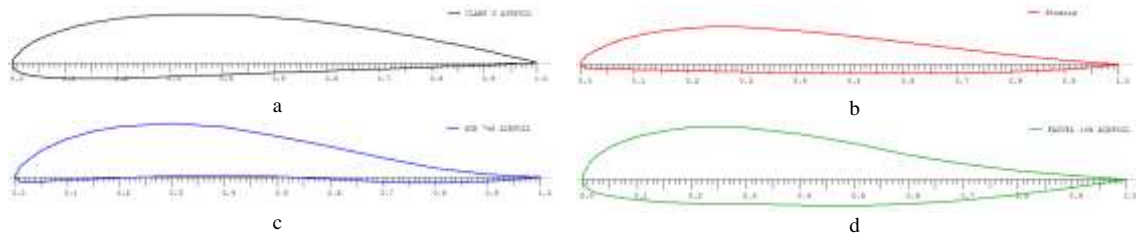

FIG. 2 Airfoils, a.Clark Y, b.Phoenix, c.GOE 746, d.Fauvel 14%

Airfoils analyzed over the incidence range  $-5^{\circ} \div 15^{\circ}$  produced comparative polar highlighted in the figures below, the numerical data taken into account the viscous effects of the flow.

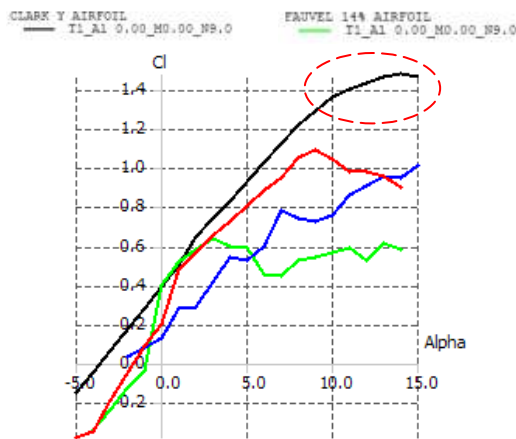

FIG. 3.  $C_l$  vs AoA

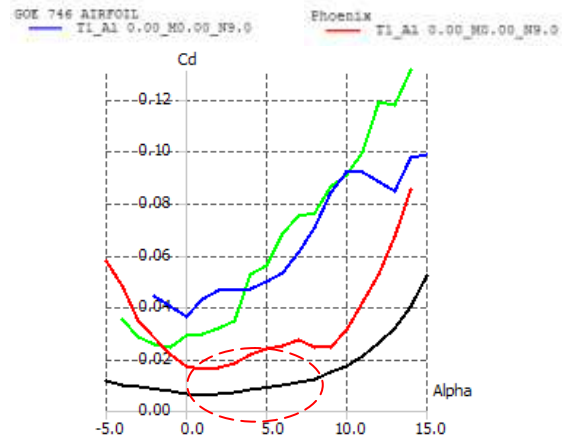

FIG. 4.  $C_d$  vs AoA

The lift coefficient polar ( $C_l$ -AoA) provides higher values for the Clark Y profile over the entire incidence range  $-5^{\circ} \div 15^{\circ}$  with a maximum of 1.47 at AoA =  $14^{\circ}$  (see Figure 3 and Table 2). The drag is also minimal for Clark Y having a value of 0.006 to AoA =  $1^{\circ}$ , see FIG. 3.

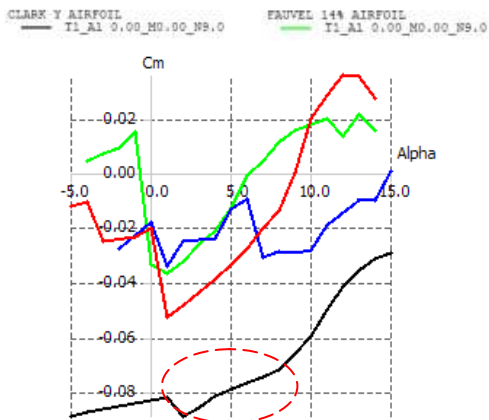

FIG 5.  $C_m$  vs AoA

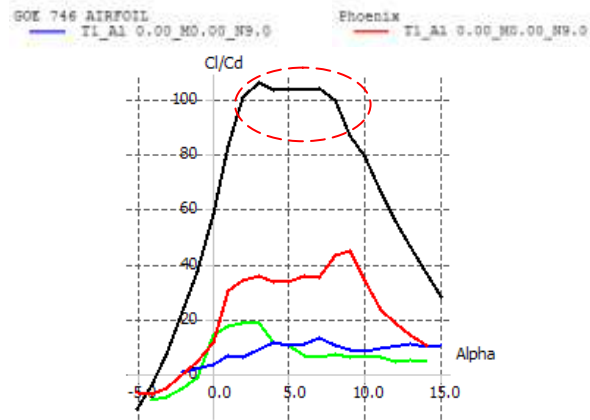

FIG. 6 Finetea  $C_l/C_d$  vs AoA

The pitch coefficient  $C_m$  (FIG. 5 and Table 2) on a positive incidence offered by Clark Y is 0.085 to AoA =  $3^{\circ}$  although a local error of calculation can be speculated in view of this isolated maximum value, and for GOE 746 and Fauvel 14% shows values indicating auto-stable behavior. The theoretical aerodynamic fineness (glider ratio) has maximum values for Clark Y over 100 units per AoA =  $3^{\circ} \div 7^{\circ}$  and for the other airfoils under 50 units, FIG. 6.

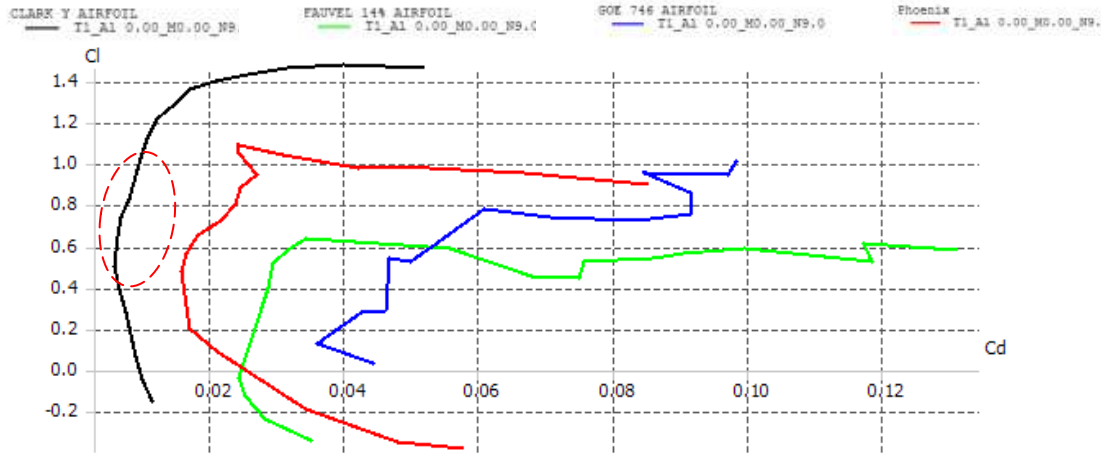

FIG. 7  $C_1$  vs  $C_d$

The polar  $C_1$ - $C_d$  (FIG. 7) indicates optimal aerodynamic behavior for Clark Y in terms of minimum drag ( $C_d = 0,01$ ) coupled with values of the lift coefficient ( $C_1 = 0,49$ ) corresponding to  $AoA = 1^\circ$ , while for  $AoA = 14^\circ$  (critical incidence) we have  $C_d = 0,039$ .

Table 2. Airfoils numeric values

Clark Y											Fauvel 14%										
alpha	Cl	Cd	Cdp	Cm	Top Str	Bot Str	Cpmin	Change	Wp	alpha	Cl	Cd	Cdp	Cm	Top Str	Bot Str	Cpmin	Change	Wp		
-5.000	-0.1456	0.0113	0.0011	-0.0001	0.0707	0.0112	-0.0391	0.0000	-0.1334	-6.000	-0.1376	0.0352	0.0278	0.0007	0.1066	0.0047	-0.1436	0.0000	0.1258		
-4.000	0.0399	0.0080	0.0000	0.0000	0.0461	0.0101	-0.0166	0.0000	-0.1663	-5.000	-0.1296	0.0205	0.0198	0.0074	0.1791	0.0011	-0.1771	0.0000	0.1211		
-3.000	0.2637	0.0065	0.0007	-0.0010	0.1980	0.0440	-1.1542	0.0000	1.1570	-4.000	-0.1239	0.0122	0.0122	0.0091	0.1429	0.0011	-0.1714	0.0000	0.1060		
-2.000	0.5061	0.0056	0.0016	-0.0010	0.2120	0.1401	-0.7822	0.0000	0.5262	-3.000	0.0696	0.0081	0.0187	-0.0190	0.0868	0.0012	-0.0491	0.0000	0.1428		
-1.000	0.7495	0.0050	0.0026	-0.0011	0.2411	0.1710	-0.6401	0.0000	0.4007	-2.000	0.1773	0.0100	0.0128	-0.0110	0.0686	0.0000	-0.1000	0.0000	0.1320		
0.000	0.9461	0.0046	0.0036	-0.0010	0.2668	0.2000	-0.5024	0.0000	0.2614	1.000	0.3785	0.0115	0.0168	-0.0110	0.0390	0.0000	-0.1789	0.0000	0.1008		
1.000	0.7395	0.0050	0.0032	-0.0010	0.2870	0.2100	-0.3809	0.0000	0.1040	2.000	0.5327	0.0167	0.0274	-0.0100	0.0226	0.0000	-0.1438	0.0000	0.1075		
3.000	0.4395	0.0068	0.0037	-0.0010	0.3061	0.2000	-1.1074	0.0000	0.1633	4.000	0.0019	0.0104	0.0097	-0.0111	0.0010	0.0000	-0.1712	0.0000	0.1000		
5.000	0.1054	0.0094	0.0047	-0.0010	0.2996	0.1600	-1.8111	0.0000	0.1041	5.000	0.1161	0.0178	0.0205	-0.0127	0.0080	0.0000	-0.1282	0.0000	0.0517		
7.000	1.1181	0.0106	0.0052	-0.0100	0.2001	0.1000	-1.1188	0.0000	0.1000	6.000	0.4100	0.0190	0.0180	-0.0087	0.0080	0.0000	-0.1111	0.0000	0.2441		
8.000	1.1070	0.0122	0.0052	-0.0110	0.1000	0.0000	-0.7016	0.0000	0.1000	7.000	0.6617	0.0190	0.0085	0.0066	0.0080	0.0000	-0.1026	0.0000	0.2382		
9.000	1.1070	0.0140	0.0057	-0.0110	0.0990	0.0000	-1.1069	0.0000	0.1000	8.000	0.7275	0.0190	0.0085	0.0121	0.1221	0.0000	-0.1215	0.0000	0.1176		
10.000	1.1070	0.0171	0.0058	-0.0110	0.0970	0.0000	-0.1721	0.0000	0.1000	9.000	0.7410	0.0190	0.0085	0.0158	0.1521	0.0000	-0.1083	0.0000	0.0991		
11.000	1.1068	0.0211	0.0059	-0.0110	0.0950	0.0000	-0.5194	0.0000	0.1000	10.000	0.7027	0.0190	0.0085	0.0178	0.1011	0.0000	-0.1188	0.0000	0.1000		
12.000	1.1065	0.0259	0.0060	-0.0110	0.0930	0.0000	-0.9190	0.0000	0.1025	11.000	0.7004	0.0190	0.0085	0.0187	0.1041	0.0000	-0.0822	0.0000	0.1011		
13.000	1.1061	0.0316	0.0061	-0.0110	0.0910	0.0000	-1.4011	0.0000	0.1050	12.000	0.6170	0.0190	0.0085	0.0180	0.1110	0.0000	-0.0710	0.0000	0.1000		
14.000	0.8770	0.0380	0.0062	-0.0110	0.0890	0.0000	-2.0441	0.0000	0.1047	13.000	0.4170	0.0190	0.0085	0.0170	0.1100	0.0000	-0.1144	0.0000	0.1000		
15.000	0.4770	0.0450	0.0063	-0.0110	0.0870	0.0000	-3.1034	0.0000	0.1018	14.000	0.1370	0.0190	0.0085	0.0160	0.0117	0.1001	-0.1061	0.0000	0.1011		

In the aerodynamic 2D conception, it is noticed that the definition of the critical flight mode is above the value of  $AoA = 14^\circ$  at Clark Y (see table), over  $AoA = 13^\circ$  at 14% Fauvel (Table 2), over  $AoA = 15^\circ$  to GOE 746 and over  $AoA = 9^\circ$  at Phoenix.

Table 3. Airfoils numeric values

GOE 746											Phoenix										
alpha	Cl	Cd	Cdp	Cm	Top Str	Bot Str	Cpmin	Change	Wp	alpha	Cl	Cd	Cdp	Cm	Top Str	Bot Str	Cpmin	Change	Wp		
-2.000	0.0548	0.00424	0.0102	-0.0174	0.5874	0.2072	-0.1790	0.0000	1.0001	-5.000	-0.1799	0.0107	0.0100	-0.0110	0.0000	0.0000	1.0000	0.0000	0.1000		
0.000	0.1110	0.0100	0.0117	-0.0177	0.5003	0.1729	-0.1713	0.0000	0.1000	-4.000	-0.1820	0.0079	0.0100	-0.0100	0.0000	0.0000	1.0000	1.0000	0.1000		
1.000	0.1798	0.0176	0.0144	-0.0158	0.3267	0.1346	-0.1513	0.0000	0.1522	-3.000	-0.2020	0.0110	0.0100	-0.0100	0.0000	0.0000	1.0000	0.0000	0.1100		
2.000	0.2380	0.0261	0.0170	-0.0140	0.1000	0.1000	-0.1000	0.0000	0.1000	0.000	0.1000	0.0114	0.0100	-0.0100	0.0000	0.0000	1.0000	0.0000	0.1000		
3.000	0.3424	0.0367	0.0202	-0.0130	0.0500	0.0771	-0.0800	0.0000	0.1000	1.000	0.1793	0.0100	0.0100	-0.0100	0.0000	0.0000	1.0000	0.1000	0.1000		
4.000	0.4858	0.0497	0.0242	-0.0120	0.0000	0.0000	-0.0000	0.0000	0.1000	2.000	0.1540	0.0100	0.0100	-0.0100	0.0000	0.0000	1.0000	0.1000	0.1000		
5.000	0.6388	0.0659	0.0291	-0.0110	0.0000	0.0000	-0.0000	0.0000	0.1000	3.000	0.1110	0.0100	0.0100	-0.0100	0.0000	0.0000	1.0000	0.1000	0.1000		
6.000	0.7858	0.0851	0.0346	-0.0100	0.0000	0.0000	-0.0000	0.0000	0.1000	4.000	0.1000	0.0100	0.0100	-0.0100	0.0000	0.0000	1.0000	0.1000	0.1000		
7.000	0.9210	0.1086	0.0407	-0.0090	0.0000	0.0000	-0.0000	0.0000	0.1000	5.000	0.0800	0.0100	0.0100	-0.0100	0.0000	0.0000	1.0000	0.1000	0.1000		
8.000	1.0410	0.1386	0.0475	-0.0080	0.0000	0.0000	-0.0000	0.0000	0.1000	6.000	0.0600	0.0100	0.0100	-0.0100	0.0000	0.0000	1.0000	0.1000	0.1000		
9.000	1.1460	0.1690	0.0546	-0.0070	0.0000	0.0000	-0.0000	0.0000	0.1000	7.000	0.0400	0.0100	0.0100	-0.0100	0.0000	0.0000	1.0000	0.1000	0.1000		
10.000	1.2370	0.1998	0.0618	-0.0060	0.0000	0.0000	-0.0000	0.0000	0.1000	8.000	0.0200	0.0100	0.0100	-0.0100	0.0000	0.0000	1.0000	0.1000	0.1000		
11.000	0.8790	0.2308	0.0692	-0.0050	0.0000	0.0000	-0.0000	0.0000	0.1000	9.000	0.0100	0.0100	0.0100	-0.0100	0.0000	0.0000	1.0000	0.1000	0.1000		
12.000	0.0110	0.2618	0.0765	-0.0040	0.0000	0.0000	-0.0000	0.0000	0.1000	10.000	0.0000	0.0100	0.0100	-0.0100	0.0000	0.0000	1.0000	0.1000	0.1000		
13.000	0.0970	0.2928	0.0837	-0.0030	0.0000	0.0000	-0.0000	0.0000	0.1000	11.000	0.0000	0.0100	0.0100	-0.0100	0.0000	0.0000	1.0000	0.1000	0.1000		
14.000	0.1830	0.3238	0.0909	-0.0020	0.0000	0.0000	-0.0000	0.0000	0.1000	12.000	0.0000	0.0100	0.0100	-0.0100	0.0000	0.0000	1.0000	0.1000	0.1000		
15.000	0.2690	0.3548	0.0981	-0.0010	0.0000	0.0000	-0.0000	0.0000	0.1000	13.000	0.0000	0.0100	0.0100	-0.0100	0.0000	0.0000	1.0000	0.1000	0.1000		

As an innovative solution, a morphing profile with variable curvature values can be used to increase of the flight incidence, which leads to the delay of occurrence of the boundary layer detachment, FIG. 8, [11].





FIG. 8 Morphing airfoil

### 4. 3D AERODYNAMICS ANALYSIS

The flight mode of fixed lifting surfaces can be analyzed from the angle of incidence but also from slip and roll angles. These analyzes provide some aspects of the aerodynamic behavior of a classical aerodynamic aircraft (Table 4) with aerodynamic surfaces having the four aerodynamic profiles previously studied (FIG. 9) under the same flight regime (Table 5).



FIG. 9 The analyzed aircraft/glider

Table 4. Geometric parameters

Parameter	Value	Parameter	Value
Span / Length / High (mm)	2000 / 800 / 160	Area	0,3 m <sup>2</sup>
Chord (mm)	150	AR	13,33

Table 5. Analysis conditions

Parameter	Value	Parameter	Value
Speed	10 m/s	Air density ( $\rho$ )	1,225 kg/m <sup>3</sup>
AoA	-5°÷15°	Cinematic viscosity	1,5x10 <sup>-5</sup> m <sup>2</sup> /s
Slip angle	0°	Iterations	300
Roll angle	0°	Analysis type	Fixed speed
Computational accuracy	0,01	Boundary conditions	Neumann

The concept of analysis is based on the mix of 3D panels / VLM at constant speed (10 m / s) without the inertial considerations and characteristic angles of calculation noted in Table 5. The most important coefficients for flight characteristics are shown in the following figures.

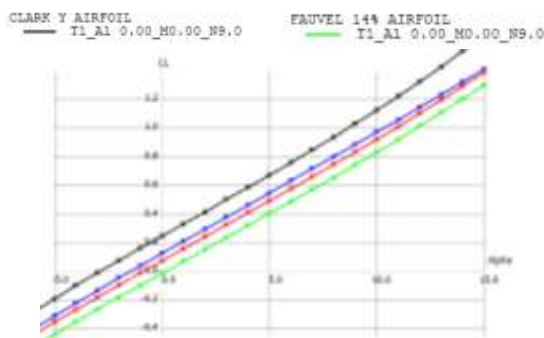

FIG. 10  $C_L$  vs AoA

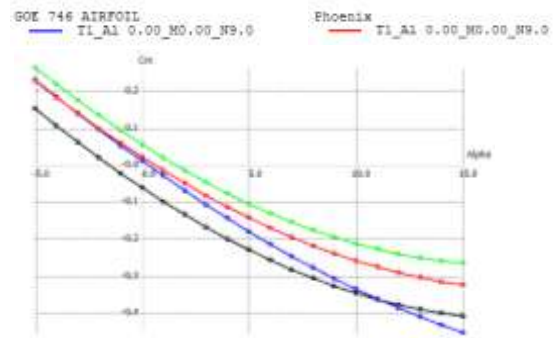

FIG. 11  $C_m$  vs AoA

The variation of the lift coefficient  $C_L$  shown in Figure 10, shows superior performance for the Clark Y profile wing for the entire incidence range of  $0^\circ \div 10^\circ$  (e.g. at  $AoA = 5^\circ$  we have:  $C_{LClark Y} = 0,66$ ,  $C_{LFauvel} = 0,39$ ,  $C_{LGoe746} = 0.54$ ,  $C_{LPhoenix} = 0.48$ ). When looking at the  $C_m$  pitch coefficient (see figure 11) at the null incidence, obviously the plane with the wing having the Clark Y profile is the most unstable (eg at  $AoA = 0^\circ$  we have:  $C_{mClarkY} = -0.06$ ,  $C_{mFauvel} = 0.055$ ,  $C_{mGoe746} = 0.01$ ,  $C_{mPhoenix} = 0.02$ ).

The roll coefficients (FIG. 12) and slip coefficient (FIG. 13) indicate a reduced dependence on the lateral stability of the geometric configurations influenced by the use of the four analyzed profiles, the net differences increase with the increase in the incidence of flight.

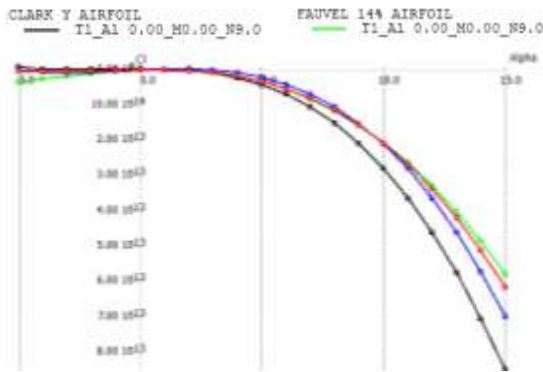

FIG. 12  $C_l$  vs AoA

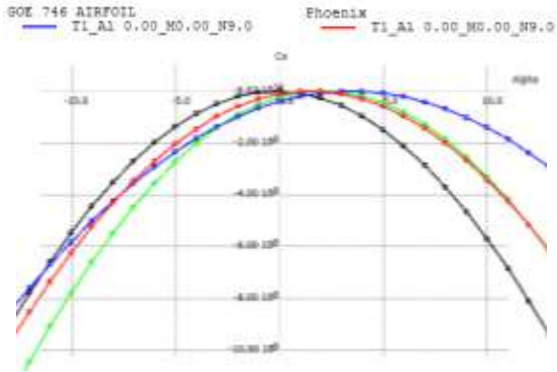

FIG. 13  $C_n$  vs AoA

For the 3D view of the  $C_p$  pressure coefficient distribution and the drag, we use the display options for each incident angle value in the calculation range ( $0^\circ$ - $15^\circ$ ), see FIG.14 for null incidence.

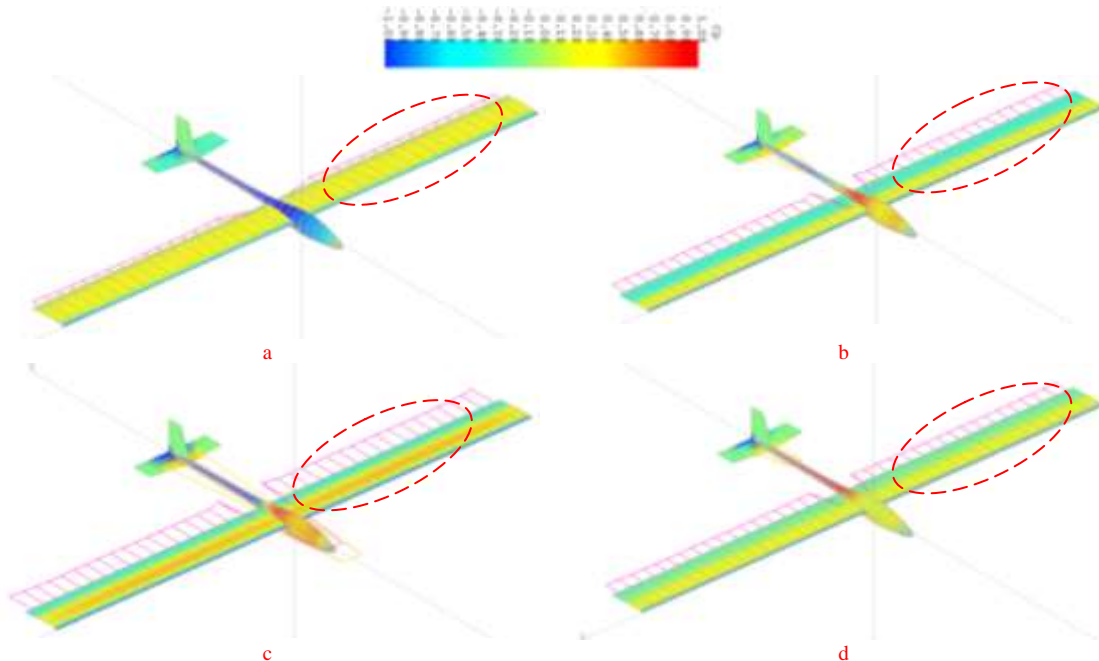
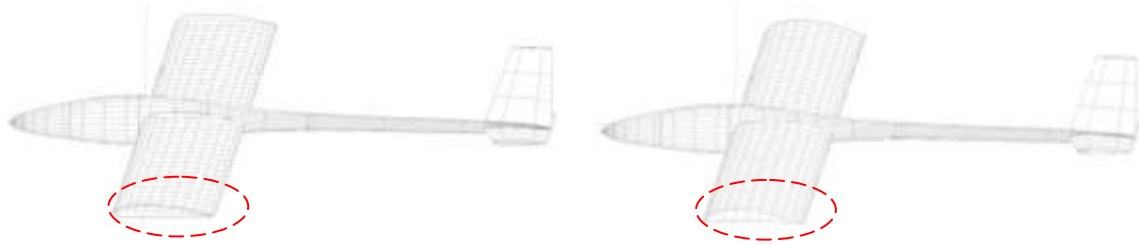

FIG. 14 The distribution of the pressure coefficient and the drag at  $AoA = 0^\circ$ , a. wing with Clark Y, b. wing with Fauvel, c. wing with Goe 746, d. wing with Phoenix

FIG. 14 shows the influence of the airfoil used on the  $C_p$  distribution and the drag (eg at  $AoA = 0^\circ$  we have:  $C_{DClark Y} = 0.004$ ,  $C_{DFauvel} = 0.017$ ,  $C_{DGoe746} = 0.022$ ,  $C_{DPhoenix} = 0.015$ ).



**FIG. 15** Morphing wing with morphing airfoil

Starting from the 2D profile approach, the morphing concept can be used to construct 3D lifting surfaces, especially for maneuvering by adaptive control [10, 11, 12], both using morphing profiles (FIG. 15) and 3D wing torsion (FIG. 16).

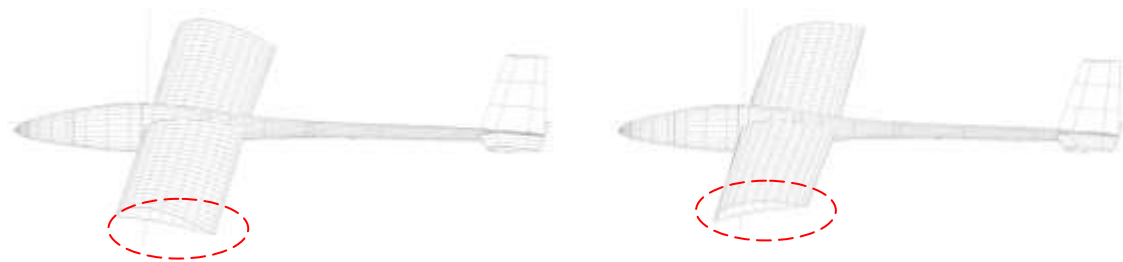

**FIG. 16** Morphing wing with 3D twist

## CONCLUSIONS

The article highlighted the usefulness of freeware tools in terms of both educational and exploratory research for geometries that can be subjected to subsequent CFD investigations with commercial software tools. XFLR5 can be useful in the educational area to support numerically, visually and phenomenological aerodynamic concepts that are extremely useful to learners and those studying in this field.

Aerodynamic analyzes performed using software tools based on free codes can generate results that are influenced by geometric fidelity, the use of external environmental analysis conditions (air density, viscosity), geometric conditions and limitations (geometric resolution / definition points) or dynamic analysis conditions (flight velocity, incidence).

## ACKNOWLEDGMENT

This article was produced with the support of the documentation of the complex project, acronym MultiMonD2, code PNIII-P1-1.2-PCDDI-2017-0637, contract 33PCCDI / 2018 funded by UEFISCDI.

## REFERENCES

- [1] Drela M., Yungren H., Guidelines for XFLR5 v6.03 (Analysis of foils and wings operating at low Reynolds numbers), 2011, available at <http://sourceforge.net/projects/xflr5/files>, accessed at 10.10.2018;
- [2] Prisacariu, V., Cîrciu, I., Boşcoianu M., Flying wing aerodynamic analysis, REVIEW OF THE AIR FORCE ACADEMY, 2/2012, Braşov, Romania, ISSN 1842-9238; e-ISSN 2069-4733, p 31-35;
- [3] Airfoil tools, available at <http://airfoiltools.com/airfoil/details?airfoil=clarky-il>, accessed at 12.10.2018;

- [4] Willner M., A Tutorial of XFLR version 1, available at <http://www.v0id.at/downloads/XFLR5-tut-v1.pdf> accessed at 14.10.2018;
- [5] Hassanalian, M., Khaki, H., & Khosravi, M. (2015). A new method for design of fixed wing micro air vehicle. *Proceedings of the Institution of Mechanical Engineers, Part G: Journal of Aerospace Engineering*, 229(5), 837–850. <https://doi.org/10.1177/0954410014540621>;
- [6] Meschia, F., 2008. Model analysis with XFLR5. *Radio Controlled Soaring Digest*, 25(2), pp.27-51;
- [7] Salam, Md Abdus. "Design, Analysis & Optimization of a Small Unmanned Aircraft.", 2015 IEEE Aerospace Conference, Big Sky, MT, USA, ISSN: 1095-323X, DOI: 10.1109/AERO.2015.7119231;
- [8] M. Satyanarayana Gupta, M. Venkateswar Reddy, D. Ramana Reddy, Design and analysis of autonomous 400mm span fixed wing micro aerial vehicle, *Proceedings Conference on Mechanical and Production Engineering*, January 2017, in Bangkok, Thailand. ISBN: 9788193137390;
- [9] <http://wiki.flightgear.org/XFLR5>, accessed at 15.10.2018;
- [10] Mircea Boscoianu, Radu Pahonie, Adrian Coman, Some Aspects Regarding the Adaptive Control of a Flying Wing- Micro Air Vehicle with Flexible Wing Tips, *WSEAS Transactions on Systems*, Issue 6, Volume 7, June 2008;
- [11] Prisacariu V., Boscoianu M., Cîrciu I., Morphing wing concept for small UAV, *APPLIED MECHANICS AND MATERIALS*, Vol. 332 (2013) pp 44-49, ISSN: 1662-7482, © (2013) Trans Tech Publications, Switzerland, doi:10.4028/www.scientific.net /AMM.332.44 OPTIROB 2013;
- [12] Valasek J., *Morphing aerospace vehicles and structures*, Wiley 2012, ISBN 978-0-470-97286-1, 306p.

## PROFESSIONALIZATION OF *CIMIC* STRUCTURE IN THE AIR FORCE

Cosmina-Oana ROMAN\*, Mihai ALEXANDRESCU\*\*

\*“Henri Conadă” Air Force Academy, Braşov, Romania (roman.cosmina@afahc.ro)

\*\*“Şpiru Haret” University, Braşov, Romania (alexa2bogdan@yahoo.com)

DOI: 10.19062/1842-9238.2018.16.3.5

**Abstract:** *Specialized literature does not determine the level and structure of CIMIC specialized elements that are made available to the Air Force during missions outside the national territory.*

*It is expected that the Air Force will participate in such missions as part of a Joint Force, either under NATO command or, as part of a multinational force, under UN or EU. Considering all these, we appreciate that the Air Force may receive specialized assistance to CIMIC in two complementary ways: by providing CIMIC with Air Force and by exploiting CIMIC activities in the area of responsibility, in favor of the Air Force.*

*Depending on the size of the Air Force, the nature and complexity of the mission, the degree of proximity and interaction with the civilian environment, we consider that CIMIC structure at the Joint Force level may provide a CIMIC cell or elements/officers/structures to the commandant of the Air Force structure.*

**Keywords:** *CIMIC (civil-military cooperation), joint forces, Air Force personnel*

### 1. INTRODUCTION

The Romanian army has not always had any preoccupations to form and train specialized forces in the field of civil-military cooperation. The relations between Romanian militaries and civilians in operational areas were based on their responsible commitment, as well as on the ability to inspire confidence, good will, respect, appreciation and consideration. With the integration of the Romanian army into NATO structures, the experience of the Alliance in the field of relations between military and civilians made it possible to adopt the *CIMIC* concept and to establish the first specialized structures in this field. The process is still in its beginnings. The perception by various categories of armed forces of the role and importance of *CIMIC* in fulfilling their missions, especially in terms of their participation in missions outside the national territory, is not yet at the expected level.

### 2. REALITIES AND PERSPECTIVES

One of the guarantees of successful of the Air Force missions engaged in peacekeeping operations is the knowledge and understanding of “*the way in which civilian actors in the national civil administration, the civil administration of the host nation, the various political bodies, international and non-governmental organizations, global economic bodies and the population itself influence the leadership structure of military operations, while explaining their fundamental principles and purposes.*”

Specialized forces can not solve all the problems that may arise in relation to civilian actors in different situations, specific to mission accomplishment. The Air Force commandant, as well as his subordinate personnel, must have the ability to fully understand both the behavior of civilian actors and, above all, their response actions. *CIMIC* provides the appropriate communication environment and opens the communication channels. Actors in communication process are often the commandants and, sometimes air force personnel. As a result, the military personnel participating in missions, from the commandant to the last combatant involved, must be aware of the culture, religion, customs, traditions, mentalities, as well as the particularities of the political and administrative system in an operation area. They must be very well informed about obligations, prohibitions, taboos, in their relations with the population and institutions in the area of operations. They should also be familiar with the principles and norms of international law applicable in the area of operations as well as with the humanitarian principles adopted by UN General Assembly Resolution 46/182, also taken over and listed in the Doctrine for Civil-Military Cooperation: humanity, neutrality, impartiality, humanitarian and developmental assistance, non-discrimination, respect for human dignity, transparency and responsibility, sustainability and capacity to act, consultation and participation, coordination, access, security and safety. The Air Force commandant, as well as his subordinate personnel, needs to know the significance of these principles in order to be able to follow them and to apply them in all circumstances.

The Manual for Civil-Military Cooperation includes, in Section 6 (*The conception of training CIMIC personnel in the Romanian Armed Forces*), the basic elements of a *CIMIC* training program, from which we can hold on to those of interest to *CIMIC* professional training of Air Force personnel. Particularly, we take into account the specific objectives of *CIMIC* professional training, subsumed in the manual to phrases of modern pedagogy: “to know”, “can”, “to be”. It is obvious that not all of the content elements contained in these phrases must be known by non-specialized *CIMIC* personnel. It is necessary to pursue those competences that support directly *CIMIC* appropriate behavior of Air Force personnel during missions. To this end, all air force personnel must participate in specific information and training programs. Analyzing the requirements of military doctrines in different fields, other documents of interest, as well as the experience of the institutions with responsibilities in the professional training of the military, we believe that the professionalization of the Air Force in the field of *CIMIC* must include the following forms of training:

1. **Formal** *CIMIC* personnel specialized training, within the framework of the national military education institutions or within allied forces;
2. **Non-formal** *CIMIC* personnel training, within some scientific, informative, documentary activities, organized by specialized education institutions or military headquarters, national or international military or civilian structures;
3. **Informal** *CIMIC* personnel training, by informing and individually documenting the staff, on the basis of their own initiative but especially through the accumulation of personal experience as a result of participation in missions outside the national territory;
4. **Immediate** *CIMIC* training of Air Force personnel within the deployment training program in a particular area of operations.

Regarding *formal training* of Air Force personnel in the field of *CIMIC*, the needs imposed by the perspective of the Air Force participation in missions outside the national territory have already led to the adoption of some decisions on the implementation in military education at all levels, of training programs with impact on *CIMIC*-related knowledge, such as knowledge of foreign languages or international and humanitarian law. We suggest, for a further stage in the improvement of study programs, the introduction, within the limits allowed by the legislation in force, of a discipline that includes elements of culture, religion and universal civilization.

Within “Henri Coandă” Air Force Academy a one-semester (56 hours) university course is underway, “*Civil-Military Cooperation*”, within the MA program, entitled “*Security Systems*”, so that Air Force officers that graduate these courses can become the most competent commandants` counselors in the field of *CIMIC*. They may be military pilots, non-flying personnel, air surveillance staff, radars officers or coming from missiles and anti-aircraft artillery branch. As the master program is open both for military and civilian personnel, it may be in the interest of the Air Force to train it in the field of *CIMIC*, personnel with higher education background who have already acquired competences of interest for this domain (foreign languages, universal culture, intercultural law, etc.) and who, if necessary, can be employed even for a limited period, to carry out missions outside the national territory. After the graduation of the first MA course, we intend to make both a quantitative and a qualitative assessment of skills acquired by graduates in relation to *CIMIC* support requirements of the Air Force carrying out missions outside the national territory. Thus, we will be able to make the necessary adjustments to ensure that the Masters is in full accordance with the needs of the Air Force.

*The non-formal training* of Air Force personnel in the field of *CIMIC* is already an ongoing process. The Air Force staff participates in national and international scientific conferences with papers, reports and interventions on *CIMIC* topics, particularly at scientific events organized by “Henri Coandă” Air Force Academy and by NDU. Officers participate in information and training activities within *CIMIC* activities organized in the country, or in training, drills and exercises organized under NATO umbrella or in joint activities with non-NATO international fora.

Between **15-18 January, 2018**, during the Romanian-American exercise “*CIMIC VICTORY*”, specific civil-military cooperation activities were carried out in Timișoara and Arad garrisons by a military team from the 1<sup>st</sup> *CIMIC* Battalion of the Land Forces Staff, together with a team of US military specialists in Civil Affairs.

**In 2017**, the Romanian Land Forces militaries participated in the largest multinational exercise in our country, SABER GUARDIAN 17 (SG17). SG17 was led by United States Land Forces deployed in Europe (USAREUR). It took place 2017 in the national territories of Bulgaria, România and Hungary, between 11-20 July, with the participation of 25.000 troops, from 22 allied and partner countries. The Romanian land forces troops belonging to “Sarmizegetusa” 2<sup>nd</sup> Mountain Brigade și to the Multinational Brigade South-East accompanied the American military from the 2<sup>nd</sup> Cavalry Regiment in DRAGOON GUARDIAN 17 marching, organizing together with the 1<sup>st</sup> *CIMIC* Battalion activities of relating with local authorities and communities in Arad, Sibiu, Râmnicu Vâlcea, Sinaia, Ploiești și Slobozia, where they organized military art exhibitions or ceremonies.

1<sup>st</sup> *CIMIC* Battalion hosted on **09 October 2014**, a joint training activity with the Ministry of Foreign Affairs, within the course on “*Post – Conflict Reconstruction and Stabilization*”. The activity brought together participants from: Afghanistan, Azerbaidjan, Egypt, Armenia, Georgia, Republic of Moldova, Montenegro, Tunisia, Belarus and Romania. The practical part of the course, meant to complete the academic training in the field, took place at the headquarters of the 1<sup>st</sup> *CIMIC* Battalion. Thematic presentations specific to *CIMIC* field were held, workshops where practical activities for post-reconstruction and post-conflict stability were carried out. On this occasion demonstrations were presented: local assessments, meetings with local leaders, meetings with local female population, conducted by *CIMIC* and *FET* (*Female Engagement Team*), humanitarian and medical assistance, as well as aspects regarding the organization and functioning of a *CIMIC* Center. The foreign participants, the representatives of the Ministry of Foreign Affairs of different echelons present at the activity, mainly appreciated the level of training of the 1<sup>st</sup> *CIMIC* Battalion staff and its substantial contribution to the joint training, the premise of efficient, timely and beneficial cooperation for both institutions.

By participating in such activities, the batallion actively contributes to the promotion of the image of the Romanian Land Forces, both at national and international level, demonstrating that it is always ready to assume and fullfil the assigned missions, following the motto: “*For the mission, for people, for the future!*”. All these activities were also attended by Air Force personnel who had the opportunity to take direct note of the support that the Air Force can benefit from during missions carried out outside the national territory.

*Informal training* of Air Force personnel should not be neglected. The permanent widening of the cultural and linguistic horizon, the mastery of at least one NATO widely spread foreign language, as well as the orientation towards a second foreign language, the knowledge of major cultures and religions, other than the Christian one, of the customs, traditions and mentalities specific to major genres the world population must be a serious personal concern for those who, in their careers, expect or wish to participate in missions outside the national territory. In particular, people with higher military or civilian education have access to such a cultural orientation.

There is, in the public debate everywhere, the dispute between narrow, expert and broad professionalism, of the Universalist type. Our perspective is that the officer, specialist, professional of any rank must also be an effective military ttool and an informed educated person. In the field of *CIMIC*, comprehensive information and extended cultural background are not just rewarding but also elements of professional competence. Air Force personnel participation in missions outside the national territory, either within a distinct Air Force structure or within joint forces, or in groups of observers, in training teams of troops from the forces of host nations, represents an excellent opportunity for non-formal training. It is about personal experience, the direct contact with reality, culture, traditions, the habits and mentalities of those we come into contact with. Here we learn, from our own experience, what is allowed and what is not, in terms of how interlocutors are, what they accept or not from our own culture. In order to accomplish missions, one must temporarily assimilate indigenous behavior, verbal and non-verbal expressions, ritual gestures and protocols, gestures and taboos. However, without all these, communication is sometimes almost impossible. But with them, the competence in the field of *CIMIC* sometimes increases in a much higher proportion than the competence acquired through formal or non-formal training carried out at home.

A particular role in acquiring *CIMIC* competences in this way is the attitude towards the population and people we come into contact with. From discussions with participants in missions outside the national territory, as well as from the military and civilian press reports regarding the participation in such missions of Romanian contingents, we have drawn some conclusions of great interest for our paper: goodwill, cultural modesty, willingness to understand and cherish the cultural aspects of others were all high-value landmarks that allowed our troops to adapt to the local population and institutions. On the contrary, arrogance, contempt, indifference, alleged cultural superiority and civilization, treatment from “the top” of civil dialogue counterparts or local militaries, practiced by representatives of participating forces, has blocked them from communicating channels, with major prejudice in mission accomplishment.

It is significant to report to a former state secretary in the Ministry of National Defense about his intention to distribute to the local population of Muslim religion from an area of operations, on Christian Christmas, a large quantity of color televisions, donated by a Romanian businessman. The Romanian soldiers entered the Muslim`s door with the TV and he tahnked nicely, and, as soon as the soldiers left, the TV was thrown out off the window.



A similar result was obtained when, at the recommendation of multinational force specialists, the local government decreed the liberation of women from the Islamic veil. According to the Romanian military reports, only brothel women have given up the Islamic veil. We cannot impose our culture on those who do not have access to it through their own culture, traditions and habits, or who consider our culture to be inappropriate. On the contrary, temporarily adapting to their own culture, we have unlimited access to the channels of communication with them.

*The immediate CIMIC training* of Air Force personnel is carried out within the general training program for deployment in a particular area of operations. As stated in the Doctrine for Civil-Military Cooperation, “*all military forces in joint operations areas need to know the specifics of civil-military cooperation missions. The type and profundity of training for this purpose is determined by the mission. The training and education of these units, prior to deployment, must include a theoretical CIMIC module and integrated training by planning and executing exercises or training specific to mission preparation.*” Thus, *CIMIC* training of Air Force personnel should not be confused with the mission preparation of specialized *CIMIC* forces. Such training involves direct identification of the operation area, starting with staff orientation on geostrategic aspects and ending with those related to the individual behavior of each participant in the operational area.

### 3. REFERENCE AND OPERATIONAL OBJECTIVES

The training of non-CIMIC specialists, within the framework of what the Doctrine for Civil-Military Cooperation calls the theoretical CIMIC module, should pursue at least the following *reference* and *operational objectives*:

**1. Reference objective:** ensuring an optimal collaboration of Air Force personnel with civilian actors in the operation areas, for successful mission accomplishment.

*Operational objectives:*

1.1. The Air Force personnel should be aware of the political, social, administrative structures which the Air Force is to come into contact with.

1.2. Staff orientation on potential barriers and vulnerabilities in dealing with civilian actors of interest to the Air Force.

1.3. Informing the staff about the possibility of unconventional, terrorist or sabotage forces that may be hostile to, or threatening to carrying out Air Force missions.

**2. Reference objective:** ensuring proper behavior of Air Force personnel in relation to the population and vectors of interest in the operation area.

*Operational objectives:* 2.1. The Air Force personnel should be aware of the culture, religion, traditions, customs and mentalities specific to the population in the operation area; 2.2. Ensuring that the Air Force personnel has such a behavior so as to avoid cultural, religious conflicts, to observe specific obligations and prohibitions, to behave with indulgence and respect with the population in the area of operations; 2.3. The Air Force personnel should know and comply with the main obligations arising from the applicable rules of international humanitarian law. On the basis of these objectives, *CIMIC* personnel, meant to provide specialized assistance for Air Force mission accomplishment trains and transmits, within the theoretical *CIMIC* module, informal and educational content for each category of personnel, depending on the degree of their involvement in relation with vector civilians.

One of the most effective tools for the direct training of Air Force staff to carry out missions outside the national territory is to develop and distribute *The Manual of the Military*, from the moment of receiving the mission.

According to the Manual for Civil-Military Cooperation, “the purpose of the manual is to provide the military with relevant information related to the specifics of operations associated with the theater of operations”. Since, as stated in the manual, “*the content of such a manual depends on the specificity of the theater of operations*”, we consider that, the content must be detailed in terms of its elaboration for the Air Force military branch. Special attention should be paid and clear procedures should be established for sections such as: geography (03), where details of relief that may have a particular impact on flight missions, *incidents reporting* (15), with clear procedures for reporting incidents of flight, *common phrases* (19), that should include helpful expressions for staff potentially arriving in critical situations in hostile territory or *contact details* (20), with procedures for contacting the flying personnel eventually arriving in hostile territory as a result of flight incidents. But, the main attention should be given, within the theoretical module, to the Air Force commandant, as well as to those specialists who have active roles in ensuring its connection with civilian actors that are of interest. Within the integrated training, exercises and practical applications *CIMIC* specialists will follow the application of knowledge acquired by the Air Force personnel within the theoretical module.

## CONCLUSIONS

The participation of the Romanian Air Forces in missions outside the national territory is no longer just a working hypothesis for military applications and training. Local and regional instability in different parts of the globe, determined by ethnic, political or religious rivalries, by actions against human rights, by terrorist and separatist actions, by actions of dissolving states has already led to the engagement of the international community through its representative bodies, but also of the North Atlantic Alliance under international mandate to protect populations and legitimate authorities. Thus, the Romanian army has not always had any preoccupations to train specialized forces in the field of *CIMIC*. The relations between Romanian military personnel and civilians in the operational areas were based on the former responsible commitment as well as on the ability to inspire confidence, good will, respect, appreciation and consideration. With the integration of Romanian army into NATO structures, the experience of the Alliance in the field of relations between military and civilians made possible the adoption of the *CIMIC* concept and the establishment of the first specialized structures in this field. The process is still in its beginnings. We also hope that the MA program proposed will be of interest to the licensed military and that it will significantly increase *CIMIC* skills in the Air Force that will thus be able to secure their own contingent of specialists in this field.

## REFERENCES

- [1] \*\*\*. S.M.G./P.F.A.-5.3. *Manualul pentru cooperarea civili-militari*, Centrul Tehnic-Editorial al Armatei, București, 2015;
- [2] \*\*\*. S.M.G./P.F.A.-5.2. *Doctrina pentru cooperarea civili-militari (CIMIC)*, București, 2013;
- [3] \*\*\*. *Doctrina armatei României*, Centrul Tehnic-Editorial al Armatei, București, 2012;
- [4] \*\*\*. *Doctrina Forțelor Aeriene*, Tipografia SMFA, Boboc, 2000;
- [5] \*\*\*. F.A.-1. *Doctrina pentru operații a forțelor aeriene*, Editura Centrului Tehnic-Editorial al Armatei, București, 2017;
- [6] \*\*\*. *Joint Doctrine Note 1/12 (JDN 1/12)*, *Strategic Communication: The Defence Contribution*, UK Ministry of Defence, January 2012, p.1-1 [https://www.gov.uk/government/uploads/system/uploads/attachment\\_data/file/33710/20120126jdn112\\_Strategic\\_CommsU.pdf](https://www.gov.uk/government/uploads/system/uploads/attachment_data/file/33710/20120126jdn112_Strategic_CommsU.pdf) (accessed on 20 February, 2018);
- [7] Michael Brzoska, Hans-Georg Ehrhart, *Civil-Military Cooperation in Post-Conflict Rehabilitation and Reconstruction*, [http://www.europarl.europa.eu/meetdocs/2009\\_2014/documents/sede/dv/sede260410\\_studyehrhart/\\_sed\\_e260410studyehrhart\\_en.pdf](http://www.europarl.europa.eu/meetdocs/2009_2014/documents/sede/dv/sede260410_studyehrhart/_sed_e260410studyehrhart_en.pdf) (accessed on 25th February, 2018).

# OPTIMAL PID CONTROLLER BASED AUTOPILOT DESIGN AND SYSTEM MODELLING FOR SMALL UNMANNED AERIAL VEHICLE

**Róbert SZABOLCSI**

Óbuda University, Budapest, Hungary (szabolcsi.robert@bgk.uni-obuda.hu)

DOI: 10.19062/1842-9238.2018.16.3.6

***Abstract:** The Proportional-Integral-Derivative (PID) controller is often considered for an old fashion technique. However, from the early 1910's it has been deeply penetrated in many control applications. The impressive history of PID controllers and experiences gained from their wide-broad control applications assign to emphasize that it is still a promising solution in a given set of control applications. Most of the commercial autopilots available for use unmanned aerial vehicle (UAV) aboard must be hand-tuned when it is installed in the UAV. This requires a well-trained, experienced UAV operator, or, ground maintenance staff able to set the PID controller parameters proper to given UAV flight mission and proper for the flight conditions during the entire flight time. The early commercial-off-the-shelves (COTS) UAV autopilots used the PID controller to steer the UAV. Recently, the PID controller is not forgotten, and, there is an intensive spread and deep penetration of the PID controllers applied for UAV automatic flight control. The purpose of the author is to highlight the control problem of the PID controller tuning, and, to introduce a new enhanced PI controller. The MATLAB scripts are created by the author supporting controller parameters' tuning activity of the UAV operators, or of the ground maintenance staff to minimize time required, and to maximize readiness of the UAV for flights.*

***Keywords:** UAV, UAV automatic flight control, PID-Controller, MATLAB.*

## 1. INTRODUCTION

Unmanned aerial vehicles (UAV) are widely spread ones both in military and civil applications. Some UAVs famous for its robust automatic flight control systems ensuring appropriate level of the flight safety comparable to that of the manned aircraft. Regarding several national regulations, there is a general rule that not necessary to apply autopilot on the board. However, if to implement it, the onboard autopilot can support UAV operators in execution of the flight missions, regulating appropriate flight parameters, ensuring automation of the safe return to home, and, in case of necessity, the automated emergency landing is also can be executed autonomous way.

There are many sellers trading with universal autopilots, like MP2028g2, MP2128g2, or, Paparazzi. The universal feature of the autopilots is an advantage, i.e. they can be implemented on the board of the wide range of the different UAV types. The universality means and requires high level of skills whilst to schedule and fit it to the given UAV platform. This study proposes an analytic method of gain scheduling of the autopilots, as the first steps in setting and defining PID-controllers' parameters.

Thus, importance of the heuristic gain selection is reduced and replaced by the analytic one of the pole placement technique. This analytic controller design method and, computer simulation can support UAV users in gain fitting and scheduling.

## 2. LITERATURE REVIEW

In spite of being relatively old fashion ones, PID-controllers still widely used both in classical and modern control engineering. Past decades modern robot applications like ground and air robots due to its privileges the PID-controller based platforms gained special attention, which are thoroughly examined in [4, 5, 6, 7, 8, 9, 11, 12, 15, 16, 17]. The affordability, the price and, finally, experiences captured in several applications of modern robotics, allowed to keep this technique at top level, and development of PID-controllers still is ongoing [21, 22].

Moreover, solution of many controller design and scheduling problems are traced back to PID-controllers, and powerful computer software support is available [19, 20].

The evolution of the UAVs is deeply analyzed in [14], and its military application in integrated air defense systems is examined in [10].

In [1] there is a competing controller synthesis design method of the famous linear quadratic regulation problem (LQR) is used to design stabilizing controller for the UAV. In the article of [18] selection of the different weighting matrices needed to solve the LQR design problem is thoroughly examined and solved, based on aerodynamic data of the small fixed-wing UAV [2, 13]. Problems related to the solution of the redundancy problems aboard of the UAV are exhaustively investigated in article of [3].

## 3. FUNDAMENTALS OF THE PID-CONTROLLER

The traditional PID-controller consists of three branches connected parallel way to each other. The series feed-forward representation of the PID-controller can be seen in FIG.1.

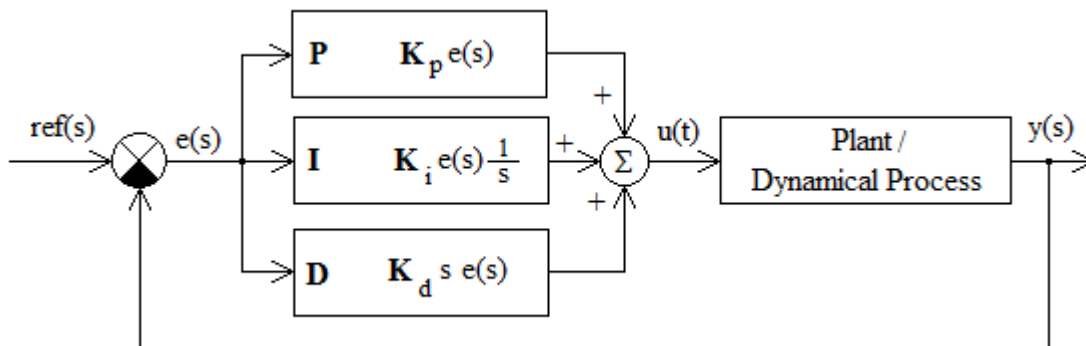

**FIG. 1** Closed Loop System Block Diagram with PID Controller in Feedforward Path.

The closed loop system mission is to establish at system output the measured output of  $y(t)$ , which is itself represents response to that of the desired process value of  $ref(t)$ . The controller mission is to minimize, or as the best case, nullify the error of  $e(t)$  over time of  $t$  by adjusting control variable of  $u(t)$ , such as to deflect aerodynamic control surface of the aircraft to its new position determined by a weighted sum of the three control terms in the PID controller.

The term P(proportional) in the PID controller is the proportional to that value of the error  $e(t)$ . The ideal I(integral) term accounts for the past values of the error  $e(t)$ , and integrates it over time. Finally, the ideal D(derivative) term represents the best estimate of the future trend of the error signal  $e(t)$ , and it is generated by the rate of error change of  $\dot{e}(t)$ . The more rapid changes are in error  $e(t)$ , the greater is the closed loop damping via increasing amount of energy existing in total sum of the control efforts of the basic terms in the controller.

The balance between those three control terms depends on those dynamic performances and requirements set for the closed loop control system. That tuning requires a priori knowledge of external disturbances and sensor noises shifting process variable  $y(t)$  apart from its desired one.

Thus, in many control applications, the lag-, the lead-, or the lead-lag compensator is used to eliminate bottlenecks of the application of the idealized I-, or D-terms.

### 3. PID-CONTROLLER OPTIMAL DESIGN USING OPTIMAL LINEAR QUADRATIC APPROACH

To highlight design problem being solved the small UAV will be considered. The aerodynamic model of the lateral motion of the small fixed-winged UAV Boomerang-60 Trainer UAV is as follows [2, 18]:

$$\dot{x} = Ax + Bu = \begin{bmatrix} \dot{v} \\ \dot{p} \\ \dot{r} \\ \dot{\phi} \end{bmatrix} = \begin{bmatrix} -0,7724 & 0 & -18,9671 & 9,0867 \\ 1,9247 & -19,9149 & 7,7565 & 0 \\ 69,1314 & -23,8689 & -2,5966 & 0 \\ 0 & 1 & 0 & 0 \end{bmatrix} \begin{bmatrix} v \\ p \\ r \\ \phi \end{bmatrix} + \begin{bmatrix} 0 & 2,2582 \\ -23,8289 & 1,5015 \\ -11,7532 & -15,2855 \\ 0 & 0 \end{bmatrix} \begin{bmatrix} \delta_a \\ \delta_r \end{bmatrix} \quad (1)$$

In equation 1  $v$  is the lateral speed,  $p$  is the roll rate,  $r$  is the yaw rate,  $\phi$  is the roll angle position,  $\delta_a$  is the angular deflection of the ailerons, and, finally,  $\delta_r$  is the change in rudder angular position. In [18] the reduced short period motion dynamic model is used to be:

$$\dot{x} = Ax + Bu = \begin{bmatrix} \dot{p} \\ \dot{\phi} \end{bmatrix} = \begin{bmatrix} -19,9149 & 0 \\ 1 & 0 \end{bmatrix} \begin{bmatrix} p \\ \phi \end{bmatrix} + \begin{bmatrix} -23,8289 \\ 0 \end{bmatrix} \delta_a \quad (2)$$

Using matrices  $\mathbf{A}$  and  $\mathbf{B}$ , and supposing a two dimensional identity matrix for  $\mathbf{C}$ , and zero matrix for feed-forward matrix  $\mathbf{D}$  in the state space model, the system was controllable and observation has been examined. The short period (single degree-of-freedom) motion dynamic model is we have dealt with is controllable and observable.

The block diagram of the UAV autopilot proposed can be seen in FIG. 2.

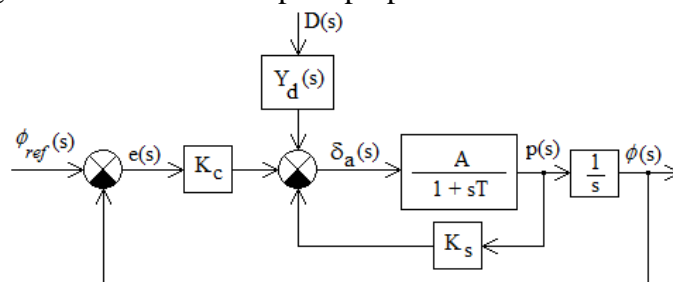

FIG. 2 Roll Angle Autopilot of the UAV with External Disturbance.

The feedforward controller is represented with P-term as the first trial to be used for design of the optimal LQR controller. In [18] the design problem is solved for following weights applied in LQR problem solution:

$$\mathbf{Q} = \begin{bmatrix} 1 & 1 \\ 0 & 10 \end{bmatrix}; \mathbf{R} = 1 \quad (3)$$

The optimal full state feedback gain matrix  $\mathbf{K}$  and the cost matrix  $\mathbf{P}$  are calculated to be [18]:

$$\mathbf{K} = [K_s \quad K_c] = [0.5656 \quad 3.1623]; \mathbf{P} = \begin{bmatrix} 0.0237 & 0.1327 \\ 0.1327 & 4.4316 \end{bmatrix} \quad (4)$$

Using Eq. 1 gain and time constant of the UAV dynamics can be derived to be:

$$A = 1,196536262; T = 0,050213659 \text{ s} \quad (5)$$

The time domain analysis of the autopilot of the UAV represented in FIG.3 [19, 20].

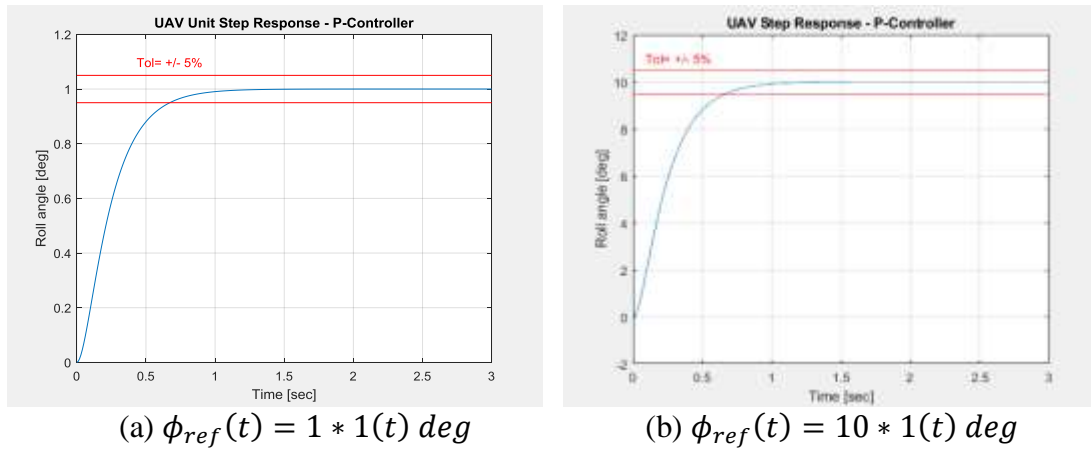

**FIG. 3** Time Domain Analysis of the UAV Closed Loop Automatic Flight Control System. (MATLAB-script: R. Szabolcsi).

From FIG. 3 it is evident that if to set 5% of tolerance field to derive settling time, for the case when the UAV autopilot is subjected to unit change in roll angle, the settling time is  $\approx 0,6$  sec, whilst for more intensive maneuvers, when the desired value of the roll angle at the closed loop control system input is 10 deg., the settling time is increased till that of  $\approx 0,7$  sec. In spite of being increased, the settling time is still kept in the range of proper and acceptable time range ensuring agile response of the UAV to the control reference input of the roll angle being stabilized.

Stability of the roll angle autopilot closed loop control system can be evaluated using FIG. 4 [19, 20]. From FIG. 4 it is evident that calculated closed loop poles are negative ones, i.e. they lie on the left-hand side of the complex plain. This means, that closed loop system time domain behavior is stable, being aperiodic, exponential one, and settling time  $t_{ss}$  mostly determined by the pole being real located at  $(-5,08+0*j)$ .

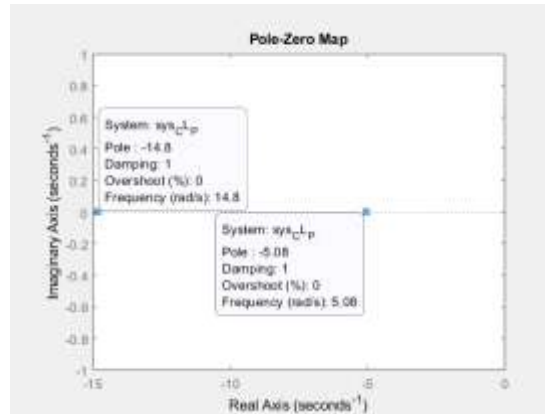

**FIG. 4** Pole-Zero Map of the UAV Closed Loop Automatic Flight Control System – P-Controller Case (MATLAB-script: R. Szabolcsi).

The closed loop control system stability is also can be examined using open loop system Bode diagrams [19, 20]. The roll angle autopilot open loop control system Bode diagram, with stability margins can be seen in FIG.5.

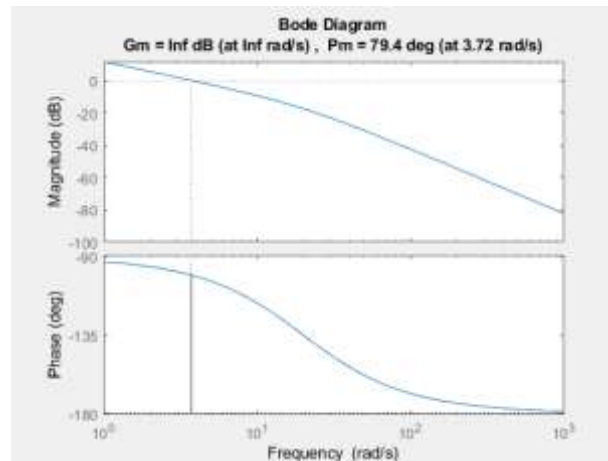

**FIG. 5** UAV Open Loop System Bode Diagram – P-Controller Case (MATLAB-script: R. Szabolcsi).

From FIG. 5 it is easily can be determined that the closed loop automatic flight control system of the UAV is stable one due to infinite gain margin and due to positive phase margin of +79,4 degrees measured at 3,72 rad/sec crossover frequency. It is evident, that in case of positive gain and phase margins the UAV roll angle closed loop control system is stable.

The UAV autopilot closed loop control system based upon P-controller has been tested for disturbance rejection ability. The external disturbance considered to behave with unit step feature, i.e.  $D(t)=I*I(t)$ , and, there is no change in roll angle reference, i.e.  $\phi_{ref}(t) = 0$ . Results of the computer simulation can be seen in FIG. 6 [19, 20].

Using final value theorem of the well-known Laplace-transformation yields to:

$$\lim_{t \rightarrow \infty} \phi(t) = \lim_{s \rightarrow 0} s\phi(s) = \lim_{s \rightarrow 0} sW_D(s)D(s) = \lim_{s \rightarrow 0} W_D(s) = \frac{1,1965}{0,002521s^2 + 1,6767s + 3,7821} \cong 0,3162 \text{ deg} \quad (6)$$

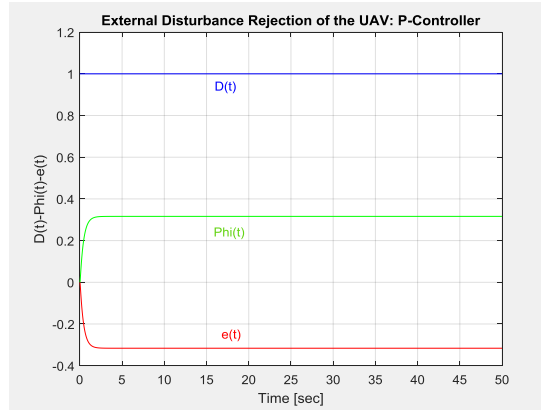

**FIG. 6** Analysis of the Disturbance Rejection Ability of the UAV (MATLAB-script: R. Szabolcsi).

The error signal can be derived as:

$$e(\infty) = -\phi(\infty) \cong -0,3163 \text{ deg} \quad (7)$$

From equation (7) it is easy to discover that the UAV P-controller is unable to eliminate unwanted consequences of the external disturbance  $D(t)$ , and there is a remaining static error measured in zero value roll angle stabilization process.

If the disturbance  $D(t)$  represents the 0-Type, or 1-Type (single integrator) disturbance signal, unwanted effects from those mentioned above signals can be totally eliminated with no static error. If the disturbance  $D(t)$  behaves with 2-Type (double integrator) feature, there is a remaining static error measured for zero roll angle holding. Finally, if the closed control system is subjected to the 3-Type (triple integrator), or, higher type disturbances, the closed loop control system will diverge, losing its stability.

It is well-known from automatic control systems' theory that such case can be handled and static error can be eliminated using PI-controller instead of the static gain of  $K_c$  with the following model:

$$Y_c = K_c + \frac{1}{sT_I} = \frac{sT_I K_c + 1}{sT_I}; \quad K_c = 3,1623 \text{ V/deg}; \quad T_I = \frac{1}{K_I} = 10 \text{ s} \quad (8)$$

Using PI-controller described in equation (8) reference signal tracking ability of the UAV closed loop control system has been tested. Results of the computer simulation can be seen in FIG. 7.

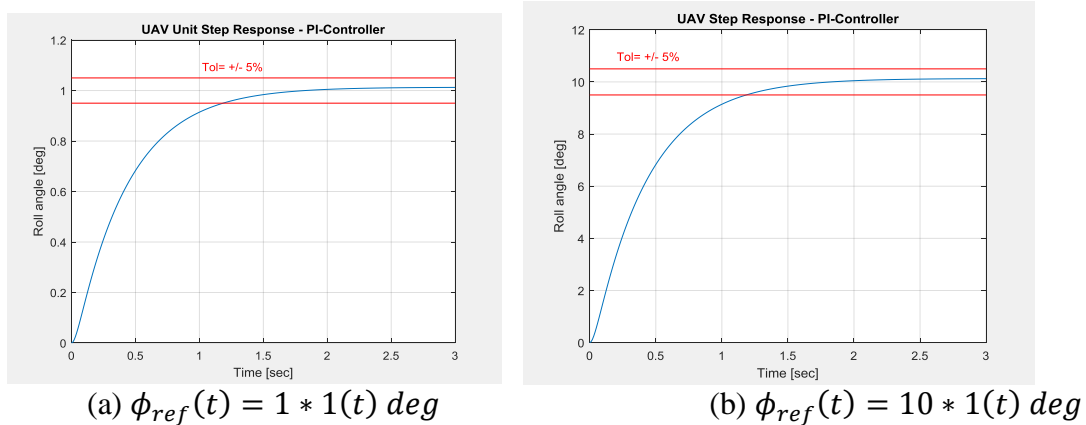
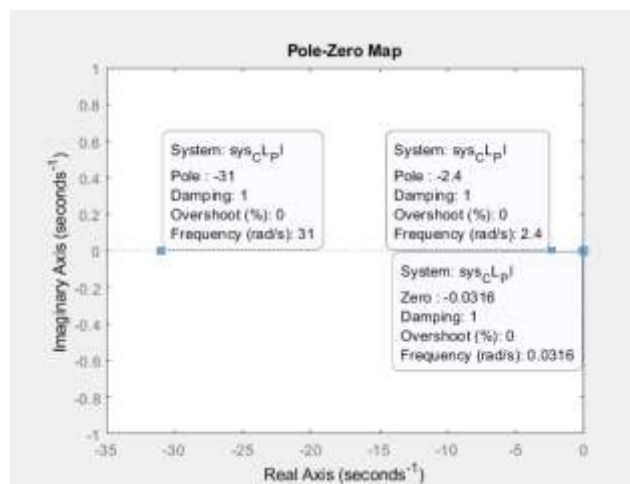

**FIG. 7** Time Domain Analysis of the UAV Closed Loop Automatic Flight Control System. (MATLAB-script: R. Szabolcsi).



From FIG. 7 it is easily can be seen that if to apply 5% of tolerance field to derive settling time, for the case when the UAV autopilot is subjected to a unit step change in roll angle, the settling time is  $\approx 1,2$  sec. For more agile and aggressive maneuvers, when the desired value of the roll angle at the closed loop control system input is 10 deg., the settling time is increased till that of  $\approx 1,7$  sec. That kind of the increase of the settling time related to that value of the case when UAV is controlled by P-controller, sometimes, can't be tolerated. The closed loop system time domain response can be accelerated via applying the D-term in the controller framework, or via applying the lead-compensator scheduled proper way.

Stability of the roll angle autopilot closed loop control system also can be evaluated using FIG. 8 [19, 20]. From FIG. 8 it is evident that calculated closed loop poles are negative ones, i.e. they lie on the left-hand side of the complex plain. This means, that closed loop system time domain behavior is stable, being aperiodic, exponential one, and settling time  $t_{ss}$  mostly determined by the pole located at  $(-2,4+0*j)$ . The system has a zero (FIG. 8) located at  $(-0,0316+0*j)$  cancelling the pole of the closed loop control system located at  $(-0,0321+0*j)$ .



**FIG. 8** Pole-Zero Map of the UAV Closed Loop Automatic Flight Control System – PI-Controller Case (MATLAB-script: R. Szabolcsi).

The closed loop control system stability based upon PI-controller is evaluated using open loop system Bode diagram, which can be seen in FIG. 9 [19, 20].

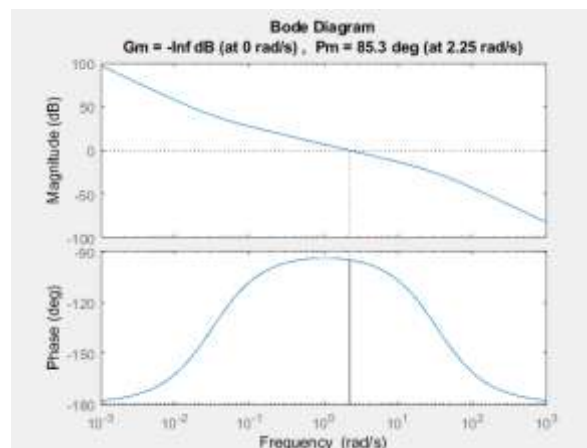
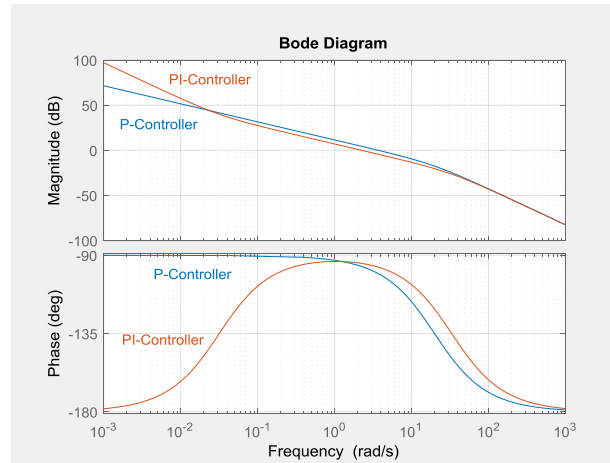

**FIG. 9** UAV Open Loop System Bode Diagram PI-Controller Case (MATLAB-script: R. Szabolcsi).

Comparing Bode diagrams of the UAV closed loop control system based upon P-controller (FIG. 5), and the UAV closed loop control system based on PI-controller (see FIG. 9) it is evident, that phase margin is increased to that of 85,3 deg at crossover frequency of 2,25 rad/s, which stands for more robust closed loop control system. From FIG. 9 it is easy to see that the open loop control system based upon PI-controller is the 2-Type system due to open loop transfer function of the form:

$$Y_{O.L.} = \frac{(1+31,623s)}{10s} \frac{1}{(16.767+0,0502s) s} \quad (9)$$

The gain curve starts with slope of - 40 dB/D, After, at frequency of  $1/K_c T_I = 0,0316$  1/s derivative term in the numerator starts to introduce slope of +20 dB/D, and resulting slope of the gain curve streams to slope of - 20 dB/D. Finally, at frequency of  $1/0,0502$  1/s and after, the first order term will start to change slope of the gain curve for -20 dB/D. At the crossover frequency of 2,25 rad/s the slope of the gain curve is -20dB/D, i.e. the closed loop control system of the UAV is stable. However, the crossover frequency is changed from its initial value of 3,72 rad/s to that of 2,25 rad/s. The open loop control systems of the UAV can be compared using FIG. 10.



**FIG. 10** UAV Open Loop System Bode Diagram: P-Controller vs PI-Controller Case (MATLAB-script: R. Szabolcsi).

From FIG. 10 It is evident that the crossover frequency  $\omega_c$  is decreased. It is well-known from theory of automatic control systems that approximated settling time  $t_{ss}$  lies in between the range of:

$$\frac{\pi}{\omega_c} \leq t_{ss} \leq \frac{3\pi}{\omega_c} \quad (10)$$

From Eq. (10) it is easy to conclude that any decrease in crossover frequency  $\omega_c$  will tend the UAV closed loop control system to increase its settling time  $t_{ss}$ .

FIG. 11 serves to compare time domain responses of those two controllers, being P-, or PI-type ones, implemented in the closed loop control system of the UAV in reference signal tracking missions.

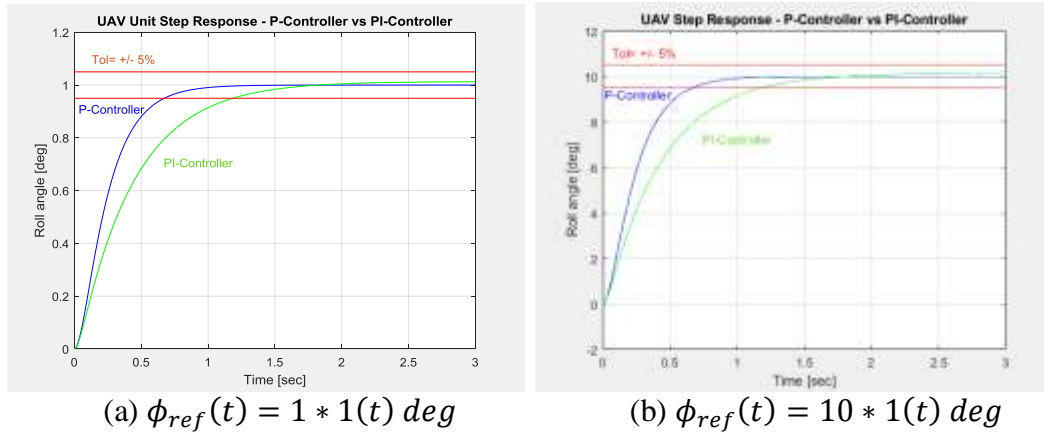

**FIG. 11** Time Domain Analysis of the UAV Closed Loop Automatic Flight Control System. (MATLAB-script: R. Szabolcsi).

The advantage of the PI-Controller is in ability to omit unwanted effects generated by the external disturbance  $D(t)$ . The UAV closed loop control system depicted in FIG. 2 has been tested for disturbance rejection ability. Results of the computer simulation are highlighted in FIG. 12 [19, 20].

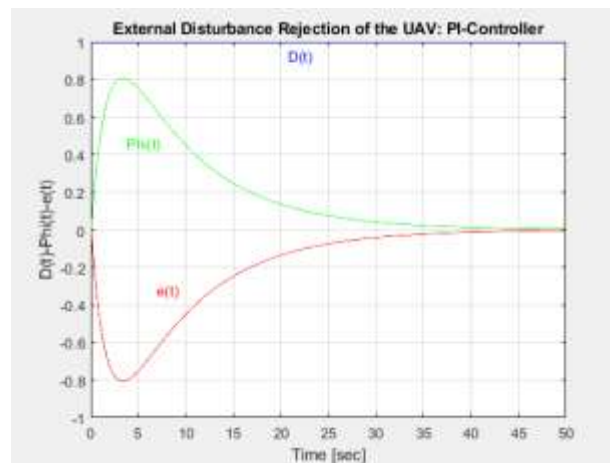

**FIG. 12** Analysis of the Disturbance Rejection Ability of the UAV (MATLAB-script: R. Szabolcsi).

Regardless to emphasize that PI-controller is able to wash out (FIG. 12) unwanted effects from external disturbances, and, the zero roll angle reference can be kept to be constant, which is a case in many typical flight phases like cruising, circling, etc.

FIG. 13 serves to compare time domain responses of those two controllers being implemented in the closed loop control system of the UAV in analysis of the external disturbance rejection capabilities.

From FIG. 13. it is evident that PI-controller will perform well in disturbance rejection missions, however, settling time is increased to that value of  $t_{ss} \cong 27 \text{ sec}$ , what is a bottleneck of the application of the traditional PI-controller.

The early discussions of this paper stated that settling time can be increased via introducing D-term in the controller structure (FIG. 1.). As the first approximation, let us suppose that controller transfer function is as follows:

$$Y_c = K_c + \frac{1}{sT_I} + sT_D = \frac{sT_I K_c + 1 + s^2 T_D T_I}{sT_I}; \quad K_D = T_D \tag{11}$$

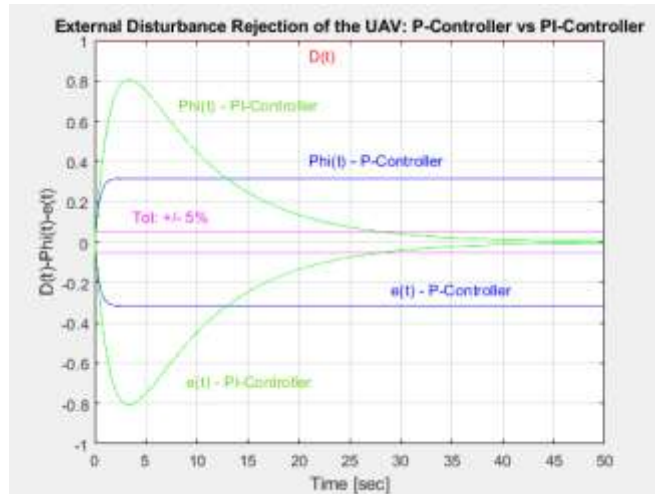
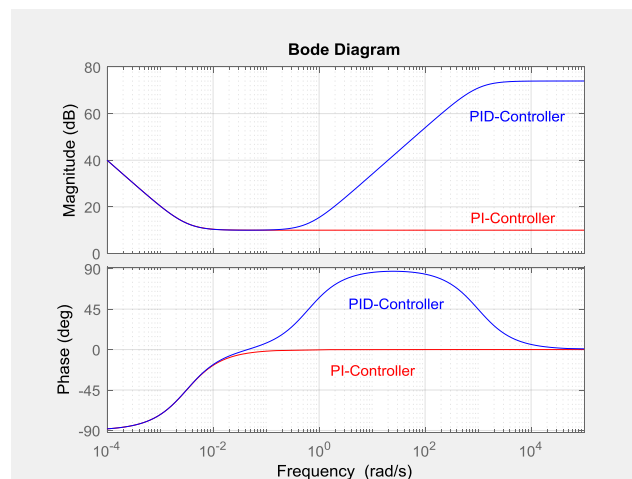

**FIG. 13** Time Domain Analysis of the UAV Closed Loop Automatic Flight Control System. (MATLAB-script: R. Szabolcsi).

It is evident that equation (11) describes the *not proper* controller transfer function due to higher order ‘s’ polynomial of the numerator than denominator has. To eliminate that bottleneck the order of the denominator ‘s’ polynomial must be increased to that of two as per the minimum so as to get proper, or as the best strictly proper dynamic model of the controller. Thus, one might have such approximation of the lead controller transfer function:

$$Y_c = K_c + \frac{1}{sT_I} + sT_D \cong \frac{sT_I K_c + 1 + s^2 T_D T_I}{sT_I(1 + sK)}; \quad K \rightarrow 0 \quad (12)$$

It is worth to mention that PID-controller itself represents the band-rejection filter. The Bode diagram of the previously applied PI-controller and the augmented PID-controller is depicted in FIG.14.



**FIG. 14** Frequency Response Functions of the PI-, and augmented PID-Controllers. (MATLAB-script: R. Szabolcsi).

From FIG. 14. it can be easily seen that PI-controller represents the low-pass filter, whilst the PID-controller is the band-stop one, and further scheduling of the controller parameters like  $K_c$ ,  $T_I$ ,  $T_D$ , and finally,  $K$ , is necessary.

Second way to increase crossover frequency  $\omega_c$  determining settling time  $t_{ss}$  (see Eq. 10) is to select the lead-compensator being active or passive, for control purpose. The transfer function of the lead compensator is as follows:

$$Y_{lead} = K_{lead} \frac{1+sT_1}{1+sT_2}; \quad 0 < K_{lead}; \quad T_1 > T_2 \quad (13)$$

Using Fig. 10. the lead compensator parameters are chosen to be:

$$T_1 = 10 \text{ sec}; \quad T_2 = 0,03 \text{ sec}; \quad K_{lead} = 200 \quad (14)$$

The forward path enhanced PI-controller transfer function, leaning on Eq. (8) and Eq. (13), will have the form of:

$$Y_c = \frac{sT_I K_c + 1}{sT_I} K_{lead} \frac{T_1 s + 1}{T_2 s + 1} \quad (15)$$

The Bode diagram of the previously applied PI-controller and the PI controller enhanced with the lead compensator is represented in Fig. 15. From Fig. 15. it is evident that the proposed enhanced PI controller behaves like a band-stop filters do, and the proposed enhanced PI controller increases open loop gain sufficiently compared to that of the gain provided by the PI-controller.

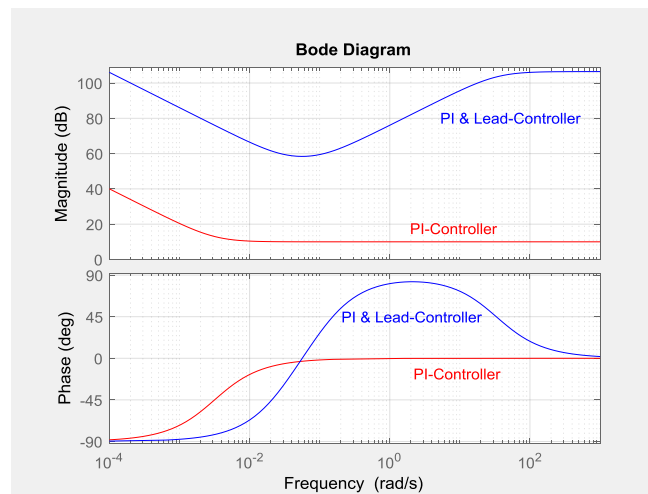
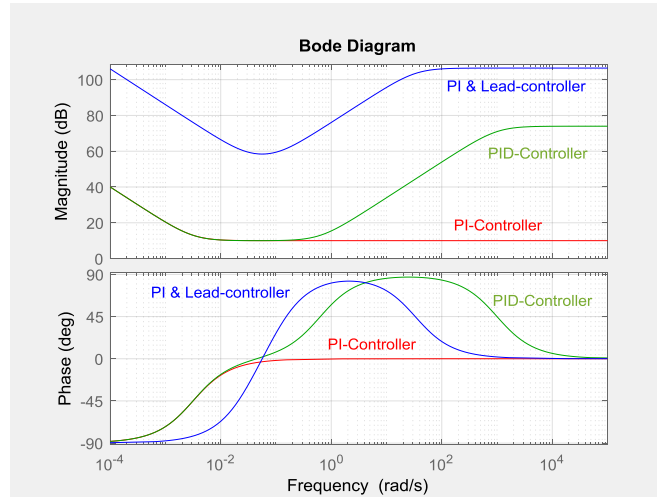

**FIG. 15** Frequency Response Functions of the PI-, and enhanced PI-Controllers. (MATLAB-script: R. Szabolcsi).

Finally, comparison of those three controllers represented in this article, say, PI-, augmented PID-, and enhanced PI controllers can be conducted using FIG. 16 [19, 20].

Using FIG. 16. the frequency domain behavior of those three controllers mentioned above can be evaluated. The gain provided by the active enhanced PI-controllers increase gains sufficiently. The positive phase angle shift is tightened in the mid frequency range, compare to that of the PID-controller proposed.

The closed loop system of the UAV roll angle control system has been tested in time domain. Results of the computer simulation can be seen in FIG. 17.



**FIG. 16** Bode Diagrams of the PI-, augmented PID, and enhanced PI-controllers. (MATLAB-script: R. Szabolcsi).

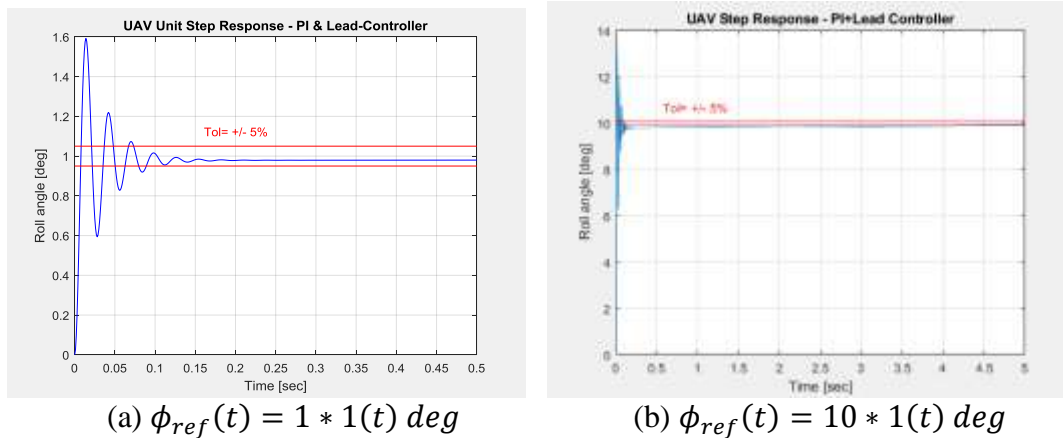

**FIG. 17** Time Domain Analysis of the UAV Closed Loop Automatic Flight Control System. (MATLAB-script: R. Szabolcsi).

Using FIG.17 it is evident that the UAV roll angle closed loop control system has significantly faster response to its roll angle references. For the unit step input the settling time is decreased to that of 0,1 sec. The only disadvantage is that the roll angle closed loop control system became more oscillatory. If the percent overshoot is out of the range being defined in advance, further schedule of the forward controller parameters in needed.

Time domain behavior of those systems having PI-, and enhanced PI controllers can be compared using FIG. 18.

Using FIG. 18 It can be stated that both transient peak time and settling time were improved if to implement enhanced PI controller, which eliminates bottleneck of the traditional PI controller's increasing settling time of the closed loop roll angle control system of the UAV.

The UAV roll angle open loop control system based upon enhanced PI controller Bode diagram can be seen in FIG. 19, and, comparison of the three controllers proposed for use in this paper can evaluated using FIG. 20 [19, 20].

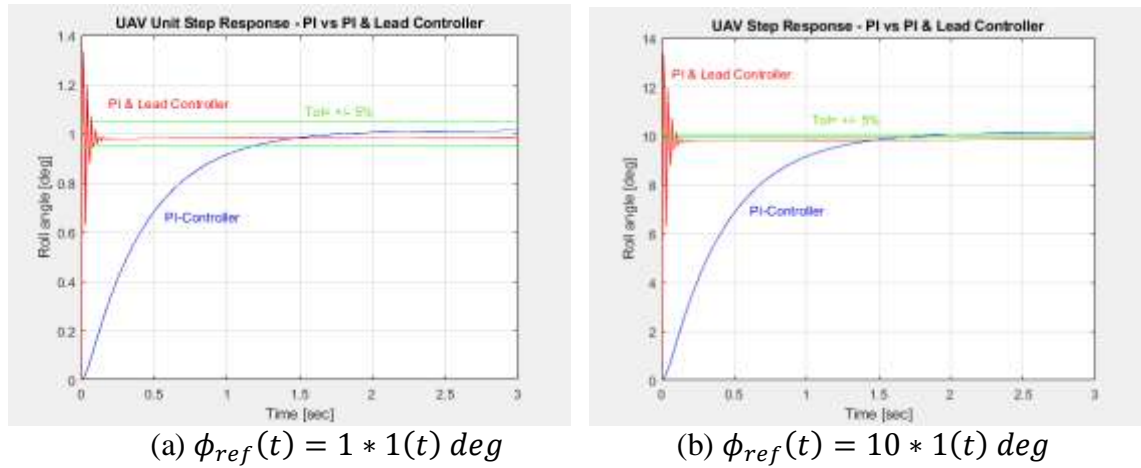

FIG. 18 Time Domain Analysis of the UAV Closed Loop Automatic Flight Control System. (MATLAB-script: R. Szabolcsi).

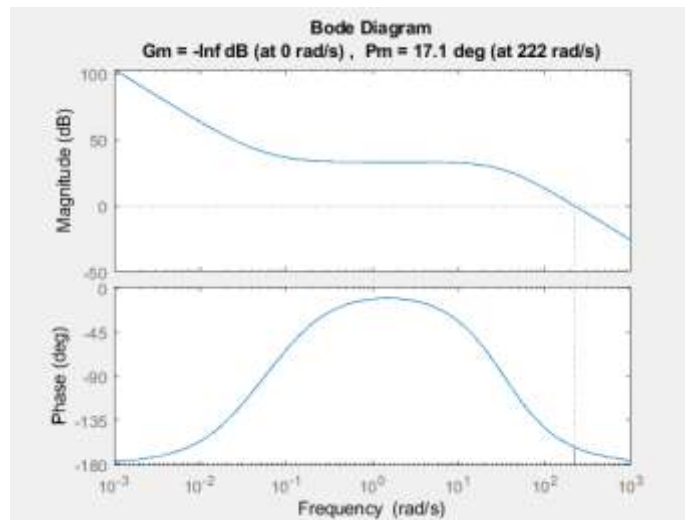

FIG. 19 UAV Open Loop System Bode Diagram: enhanced PI Controller Case (MATLAB-script: R. Szabolcsi).

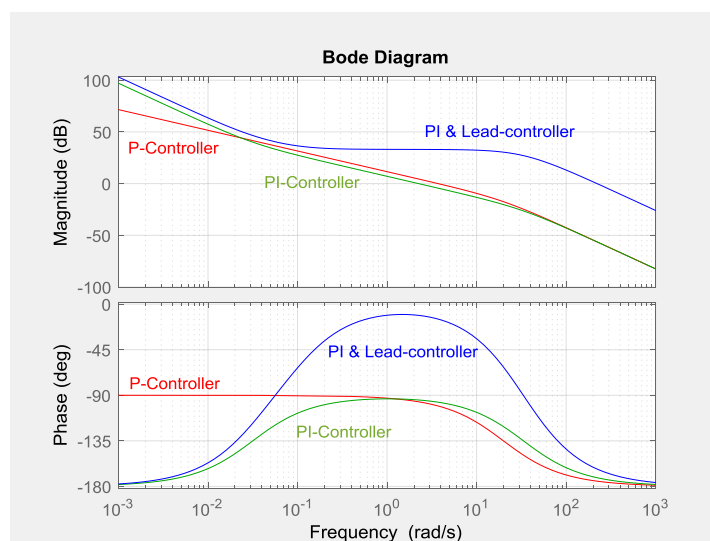

FIG. 20 Bode Diagrams of the Open Loop Control Systems of the UAV. (MATLAB-script: R. Szabolcsi).

From FIG. 19 it is evident that crossover frequency is increased from that value of 2,25 rad/s (PI controller case) to its new value of 222 rad/s, i.e. settling time defined by Eq (10) is decreased, and, the UAV roll angle closed loop control system became more faster.

The only feature remained to be examined is the time domain analysis of the UAV roll angle closed loop control system in disturbance rejection mission. In that fashion, the external disturbance  $D(t)$  is supposed to behavior with unit step function.

Leaning on final value theorem of the Laplace transformation yields to:

$$\lim_{t \rightarrow \infty} \phi(t) = \lim_{s \rightarrow 0} s\phi(s) = \lim_{s \rightarrow 0} sW_D(s)D(s) = \lim_{s \rightarrow 0} W_D(s) = \frac{0,3588s^2 + 11,96s}{0,01506s^4 + 1,0051s^3 + 73944,33s^2 + 9730,756s + 233,8} = 0 \text{ deg} \quad (16)$$

The UAV roll angle closed loop control system was tested for disturbance rejection ability. Results of the computer simulation can be seen in FIG. 21.

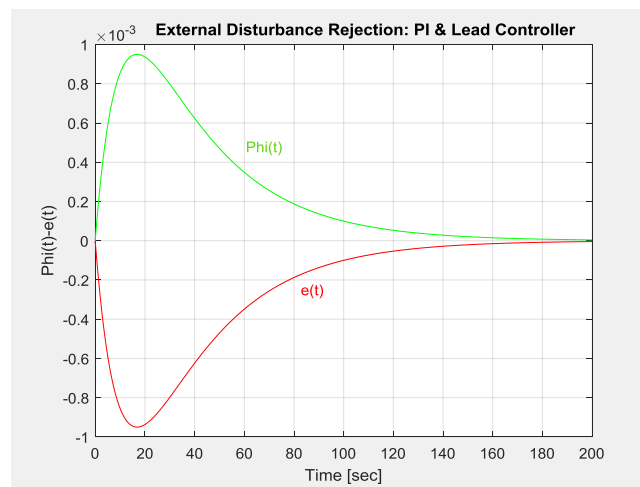

**FIG. 21** Time Domain Analysis of the UAV Closed Loop Automatic Flight Control System. (MATLAB-script: R. Szabolcsi).

From FIG. 21 it is evident that the UAV roll angle closed loop control system based upon enhanced PI controller is able to eliminate consequence of the external disturbance, which is a Type-1 input signal. It is well-known that the proposed enhanced PI controller would not degrade the open loop system type, which is equal to that of 2. In other words, the disturbance rejection ability of the newly proposed enhanced PI controller will ensure the ideal disturbance rejection, and, additionally, will accelerate the UAV roll angle closed loop control system responses. Regarding Eq (14) the enhanced PI controller is an active one, and its gain is 200, which is the only disadvantage of the proposed controller. However, the gain needed to build up the controller will not generate any difficulties in control engineering of recent days.

#### 4. CONCLUSIONS

The behind this research work was to solve the selection of the optimal controllers, and tune controllers for the new frameworks improving disturbance rejection ability of the UAV roll angle closed loop control systems.

Leaning on static controllers of the previously solved LQR design problem, few of the available controllers like traditional PI controllers, or PID controllers had been analyzed.



The PI controller is a framework able to eliminate unwanted effects from external disturbances. However, the integral feature will decrease open loop system crossover frequency, which tends the closed loop control system for slower responses.

To eliminate this disadvantage the PID controller and the enhanced PI controller were introduced. Analytical studies and computer simulations both in time and in frequency domains had shown that the proposed enhanced PI controller will keep property of the closed loop system leaning on PI controller to eliminate unwanted effects from external disturbances, whilst to eliminate disadvantage of the PI controller decelerating the closed loop control system. Moreover, the proposed enhanced PI controller accelerated the closed loop control system of the UAV via increasing its crossover frequency.

## REFERENCES

- [1] Békési Bertold, Szegedi Péter: *Preliminary Design of Controller of Longitudinal Motion of the Unmanned Aerial Vehicle Using LQR Design Method*. Proceedings of the 10th International Conference: Transport Means 2006, Kaunas, Lithuania, pp. 324-327.
- [2] Eng, P. C. S. *Path Planning, Guidance and Control for a UAV Forced Landing*. PhD Thesis, Queensland University of Technology, Australia, 2011.
- [3] Békési Bertold, Wühl Tibor: *Redundancy for micro UAVs – control and energy system redundancy*. Proc. of the International Conference Deterioration, Dependability, Diagnostics 2012, Brno, Czech Republic, pp. 123-130. (ISBN:978-80-7231-886-5).
- [4] Batmaz, A. U., Elbir, O., Kasnakoglu, C. (2013): Design of a Quadrotor Roll Controller Using System Identification to Improve Empirical Results. *International Journal of Mechanics and Manufacturing*. Vol 1, No4, pp(347-349), 2013.
- [5] Bolandi, H., Rezaei, M., Mohnesipour, R., Nemati, H., Smailzadeh, S. M. (2013): Attitude Control of a Quadrotor with Optimized PID Controller. *Intelligent Control and Automation*. Vol 4, pp(335-342), 2013.
- [6] Jose, C.V., De Paula, J.C., Leandro, G.V., Bonfim, M.C. (2013): Stability and Control of a Quad-Rotor Using a PID Controller. *Brazilian Journal of Instrumentation and Control*. Vol 1, No1, pp(15-20), 2013.
- [7] Haq, A. U., Reddy, S. G.M., Raj, C. P. P. (2014): Design, modeling and Tuning of Modified PID Controller for Autopilot in MAVs. *International Journal of Sciences & Engineering Research*. Vol 5, Issue 12, pp(506-513), 2014.
- [8] Koszewnik, A. (2014): The Parrot UAV Controlled by PID Controllers. *Acta Mechanica et Automatica*. Vol 8, No2, pp(65-69), 2014.
- [9] Tanveer, M.H., Hazry, D., Ahmed, S. F., Joyo, M.K., Warsi, F. A., Razlan, Z.M., Wan, K., Hussain, A.T. (2014): PID Based Controller Design for Attitude Stabilization of Quad-rotor. *Australian Journal of Basic and Applied Sciences*. Vol 8(4), pp(1-5), 2014.
- [10] V. Şandru, M. Rădulescu: The Use of UAV's During Actions of Integrated Air Defense Systems. *Review of the Air Force Academy*, No 3 (30) 2015, pp (133-138), 2015.
- [11] Alaimo, A., Artale, V., Barbaraci, G., Milazzo, C.L.R., Orlando, C., Ricciardello, A. (2016): LQR-PID Control Applied to Hexacopter Flight. *Journal of Numerical Analysis, Industrial and Applied Mathematics*. Vol 9-10, No3-4, pp(47-57), 2016.
- [12] Praveen, V., Pillai, A. S. (2016): *Modeling and Simulation of Quadrotor Using PID Controller*. *IJCTA*. 9(15), pp(7154-7158), 2016.
- [13] Szabolcsi, R. (2016). *Automatic Flight Control of the UAV*. Budapest: Óbuda University.
- [14] S. Pop, A. Luchian, R. G. Zmădu, E. Olea: The Evolution of Unmanned Aerial Vehicles. *Review of the Air Force Academy*, No.3 (35)/2017, pp(125-132), 2017.
- [15] Sattar, M., Ismail, A. (2017): PID Control of a Quadrotor UAV. *International research Journal of Engineering and Technology*. Vol 04, Issue 8, pp(1490-1493), 2017.
- [16] Satla, Z., Elajrami, M., Bendine, K. (2018): Easy Tracking of UAV Using PID Controller. *Periodica Polytechnica Transportation Engineering*. (Accessed 3 July 2018 at <https://pp.bme.hu/tr/article/view/10838>).
- [17] Sendoya-Losada, D.F., Quinterro-Polanco, J.D.(2018): PID Controller Applied to an Unmanned Aerial Vehicle. *ARPN Journal of Engineering and Applied Sciences*. Vol 13, No1, pp(325-334), 2018.
- [18] Szabolcsi, R.: Design and Development of the LQR Optimal Controller for the Unmanned Aerial Vehicle. *Review of the Air Force Academy No.1 (36)/2018., pp(45-54.)*

[19] MATLAB 9.4 (R2018a), User's Guide, The MathWorks, 2018.

[20] MATLAB 9.4 Control System Designer/Control System Toolbox 10.4, User's Guide, The MathWorks, 2018.

[21] [www.micropilot.com](http://www.micropilot.com) (Accessed 11 September 2018).

[22] <http://paparazzi.enac.fr> (Accessed 11 September 2018).

## AUTOMOTIVE SAFETY AND THE CRUISE CONTROL SYSTEM

Mădălina BORCAN, Cornel STANCA, Marian ALEXANDRU

Transilvania University of Brasov, Romania  
mada09b@yahoo.com; cornel.stanca@unitbv.ro; marian.alexandru@unitbv.ro

DOI: 10.19062/1842-9238.2018.16.3.7

**Abstract:** *Dozens of electronic control systems are installed on modern vehicles, meant to optimize the parameters of the functional subsystems of the vehicle as a whole. This paper integrates two of these subsystems: the active safety subsystem – the distance control subsystem assessing the distance to the front vehicles – and the subsystem controlling cruising speed. The functional validation of the two integrated subsystems has been done on a demonstrator, a motorized model powered by a DC motor. The control algorithms were implemented in a PIC microcontroller.*

**Keywords:** *automotive, safety, cruise, design, control, system, PicKit3*

### 1. INTRODUCTION

The cruise system technology presented in FIG.1 is considered as a key component of any future generation of intelligent cars. This influences driver safety and comfort and increases road capacity, maintaining the optimal separation of the vehicle from the surrounding traffic and reducing driver errors, while also optimizing resource consumption [1].



**FIG. 1.** Radar Cruise Control [2]

In this paper, two cases are presented: in the first case, we start from the premise that a machine cannot climb a slope when the system is not active, its speed being reduced or even becoming null, and in the second case when the other car arrives and the system is inactive, it will not slow down, causing an impact.

This work was realized in the current context of application development with microcontrollers, which use sensor networks for data acquisition and transmission to the implemented system.

The following objectives were pursued:

- achieving the control algorithm of the two subsystems;

- designing the electronic control system;
- implementing of the proposed system;
- implementing the control algorithm in a program loaded into a microcontroller, the application kernel.

## 2. THE ARCHITECTURE OF THE SYSTEM

The circuit will be powered at 6VDC, low-cost components will be used without affecting the network performance.

The structure of the harvested part is presented in FIG 2. The core of the application is a PIC microcontroller on which the algorithms are implemented for setting the two subsystems.

Inputs to the system are:

- analog, from the speed potentiometer and the remote sensor;
- numerical, from the activation switches of the control subsystems and the proximity sensor used to determine the speed of the drive wheels.

The system output is PWM (Pulse Width Modulation) type, used to control the DC motor speed via a driver.

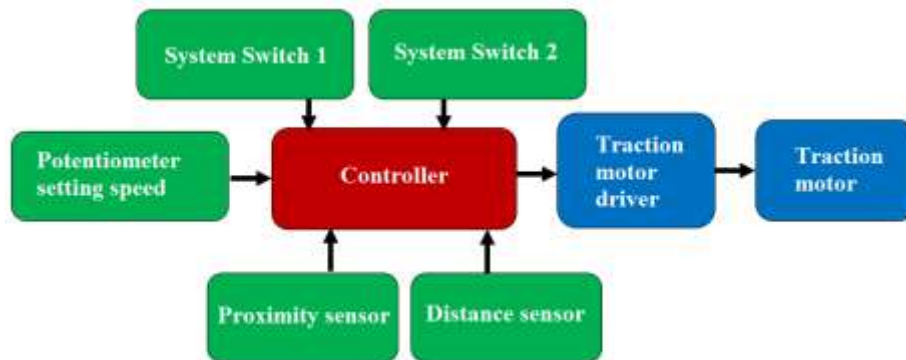

FIG. 2. The block diagram of the control system

Designing and building the electronic module is presented in FIG. 3.

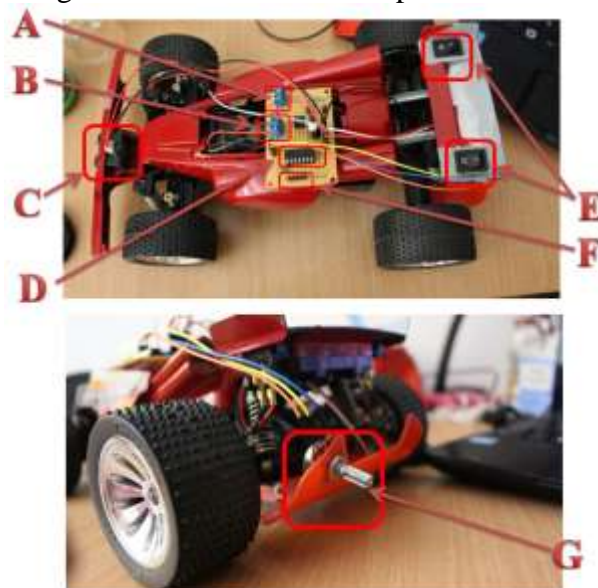

FIG. 3 A. 6Vcc power supply, B. 6Vcc power supply, C. distance sensor, D. microcontroller PIC16F1825, E. System ON / OFF buttons, F. pins for the PicKit3 programmer, G. potentiometer

The notion of proximity refers to the degree of proximity between two bodies; in technical installations there are cases in which the control of the position of a device relative to another is part of the technological process itself. Position control between moving devices, one of which represents the reference system, is done by proximity sensors. This control is exerted without direct contact between moving bodies [3].

Proximity sensors are devices that allow detecting and signaling the presence of objects in their field of action without physical contact with the respective objects. Proximity sensors have a relay feature – all or nothing – the output signal represents the presence or absence of the controlled object. [4]

For engine control a low power transistor (BD139) commanded by a small power transistor (BC109) were used, both in Darlington connection.

The simplest way to control and to obtain a variable speed, are the DC motors because the higher the applied voltage the faster the speed is. A positioning movement is composed of an acceleration, a steady speed and a braking, according to an illustrated speed trajectory (FIG. 4) [5]

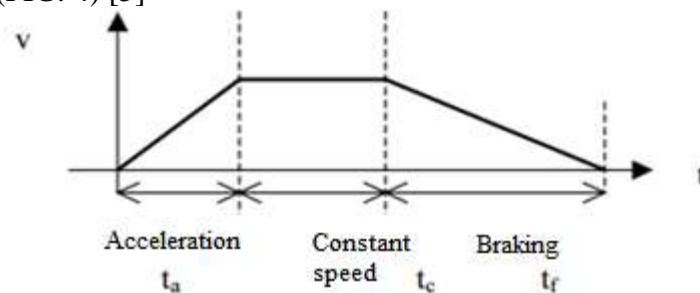

FIG. 4. Speed Trajectory

**2.1 Designing the control system.** The electronic layout of the assembly was performed in Proteus. In FIG. 5 the electronic scheme of the system, and in FIG. 6, the circuit implemented on the machine are presented, respectively.

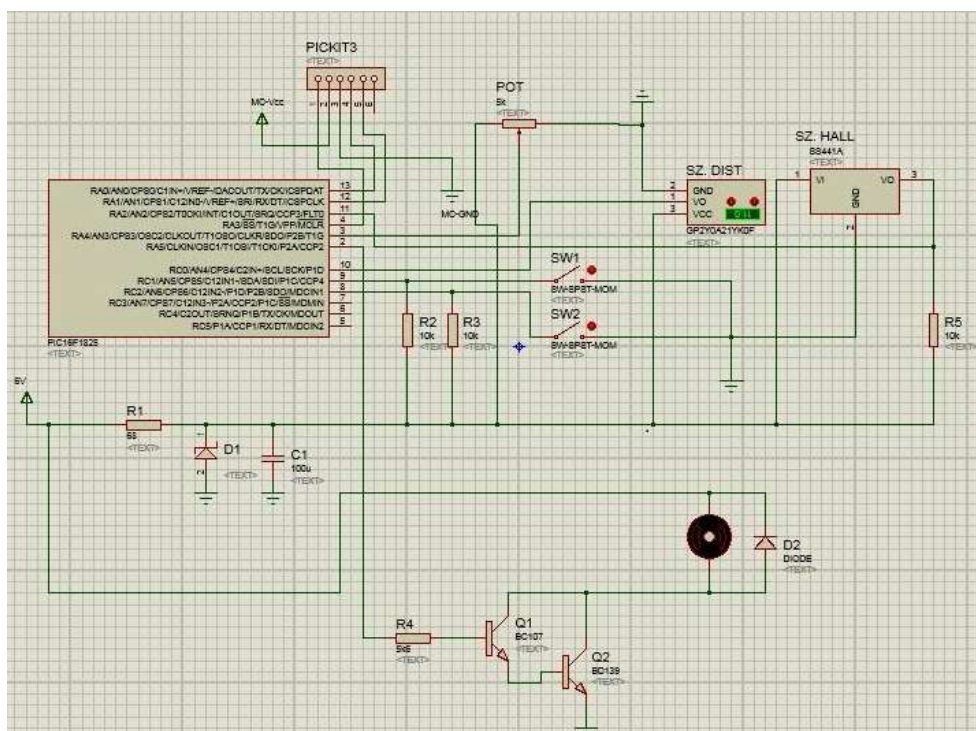

FIG. 5. Electronic diagram

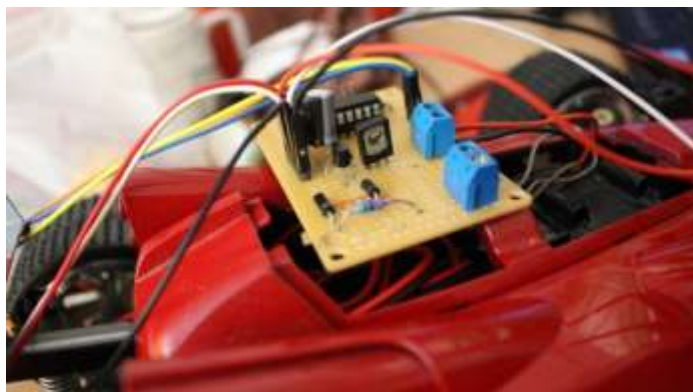

FIG. 6. The implemented circuit, mounted on layouts

### 3. SYSTEM FUNCTIONALITY

The operation of the cruise control subsystem of the vehicle is shown in FIG. 7. Vehicle speed (indirectly given by engine speed and wheel diameter) is prescribed by a potentiometer changing the potential at the analogue input to which it is coupled, and finally the prescribed fill factor of the PWM signal (DCpr) [6].

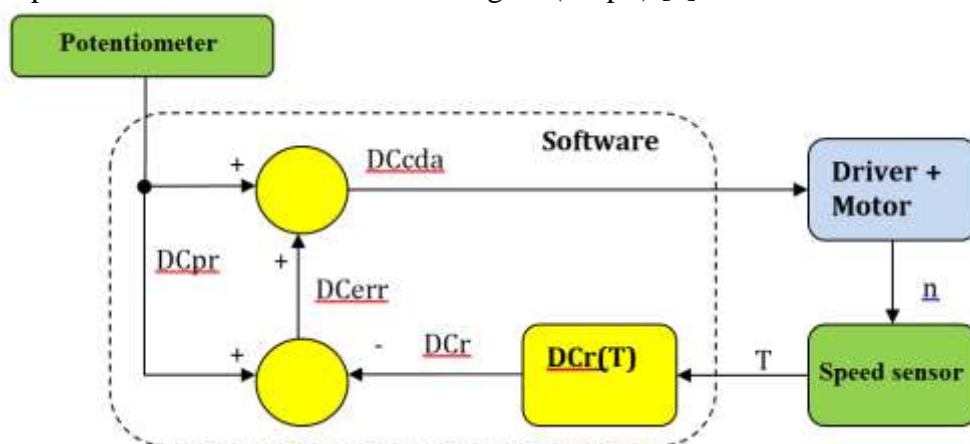

FIG. 7. Cruise Control Subsystem

The effective control of the engine is exerted by the DCcda signal which is influenced by the DCerr error signal, according to the relationship (1)

$$DCcda = DCpr + DCerr \quad (1)$$

The DCerr signal is obtained by comparing the DCpr prescription signal with that obtained through the DCr loop, according to the relationship (2)

$$DCerr = DCpr - DCr \quad (2)$$

The DCr signal is the reflection of the engine speed through the signal period obtained from the proximity sensor T according to the experimentally determined relationship (3):

$$DCr = 112 - T/2 \quad (3)$$

In this way, the decrease of the speed due to the additional load is compensated by increasing the supply voltage (increasing the filling factor) until the error is canceled.

**3.1 Experimental results.** The analysis of results led to the conclusion that this system controlled by a microcontroller is applicable to various classes of users, being a safety and resource-enhancing system.

In the first case, immediately after gluing the magnets, we tested at which distance the sensor reads the magnet, and then attached it to the demonstration car, as seen in FIG. 8.



FIG. 8. Hall sensor and/with magnets on the engine wheel – test

After reading the sensor of the 5 magnets, a rectangular signal was obtained uniformly as in FIG. 9.

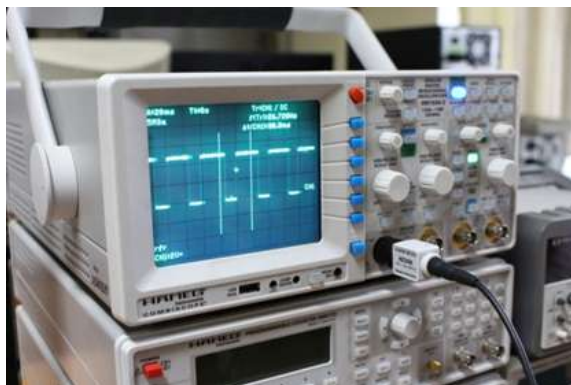

FIG. 9. The signal from the proximity sensor

Thus, the whole system fits into the current control and safety trends focused on the occupants of the vehicle. The signal from the proximity sensor varies depending on the speed of the motor that is regulated by the potentiometer, to reach the optimal operating speed to not climb the slope without activating the system, and when the system is active to increase engine power as much as it takes to climb the slope.

For the second case, to detect another vehicle in front, we used a remote sensor. When the vehicle runs on the road without other automobiles around, the cruising speed is the one intended by the driver. However, as soon as it approaches the rear of another vehicle at a prescribed distance  $DistPr$  (FIG.10), the system reacts by lowering the speed until it becomes equal to the cruising speed of the vehicle in front. If the distance between vehicles remains at the limit value, the vehicle's speed is maintained. If the distance tends to increase, then the travel speed increases, but not more than the prescribed speed of the potentiometer.

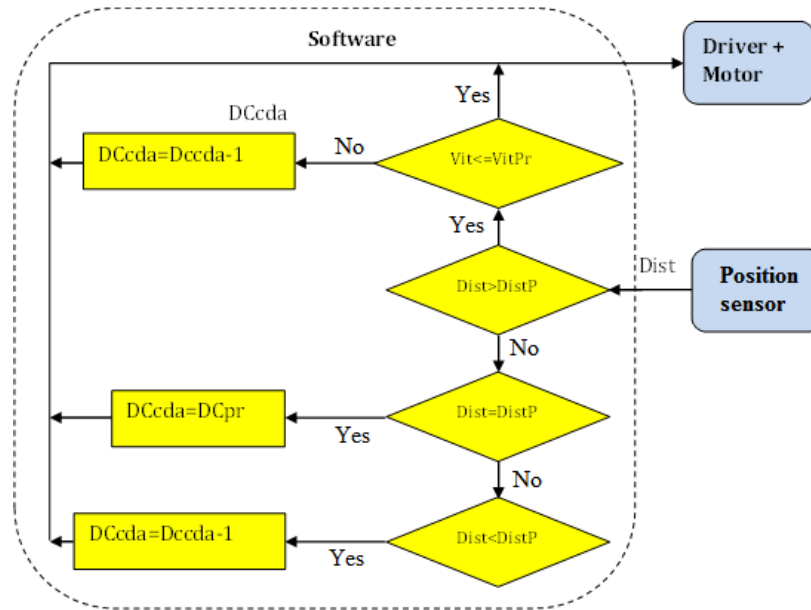

FIG. 10. The distance to the front vehicle control system

## CONCLUSIONS AND FUTURE WORK

The proposed system worked according to the experimental results. The car worked in the way we intended, climbing the slope without problems and avoided a crash in a the due time. This is an active safety system for both the driver and the passenger.

In the future, for steady downhill speed of the vehicle and to make it brake faster, it is necessary to control the DC motor in both directions by means of an H-bridge and the associated driver and thereby achieving braking. This is a drawback for the system, because it does not stop in time when the car goes downhill, the speed becomes too high and can produce an accident.

## REFERENCES

- [1] \*\*\*, *Driving the Future of Automotive Electronics*, online resource accessed in April 24, 2018, at the address [http://www.infineon.com/dgdl/Infineon-Automotive\\_Application\\_Guide-ABR-v00\\_00-EN.pdf?fileId=db3a30431c48a312011c6696b47402cc](http://www.infineon.com/dgdl/Infineon-Automotive_Application_Guide-ABR-v00_00-EN.pdf?fileId=db3a30431c48a312011c6696b47402cc)
- [2] \*\*\*, *Autoweb's Guide to... Adaptive Cruise Control*, online resource accessed in July 13, 2017, at the address <http://editorial.autoweb.com/autoweb-s-guide-to-adaptive-cruise-control/>
- [3] - <http://mecatronicastiintaviitorului.wikispaces.com/file/view/Curs-Senzori.doc>
- [4] - \*\*\*, *Sensors. Direct order. Representation of information*, online resource accessed in November 26, 2017 at the address <https://www.scribd.com/document/114438408/Senzori-Comanda-directa-Reprezentarea-informatiei#>
- [5] P. Ogrutan., *Fujitsu Microcontrollers and Graphics Controllers*, Ed. Transilvania University of Brasov, 2006, 182 pag, ISBN 973-635-621-3;
- [6] Ulsoy, A. Galip; Peng, Huei; Çakmakci, Melih (2012). *Automotive Control Systems*, Cambridge University Press. pp. 213–224. ISBN 9781107010116.



## A NOVEL DATA MINING PROCEDURE GENERATING A TYPICAL ELECTRICAL ENERGY DAILY SHAPE BASED ON VALUES FROM SMART METERING

Cătălin MIHAI\*, Marian PEARSICĂ\*\*, Laurian GHERMAN\*\*

\*SC FDEE Electrica, Brasov, Romania (catalin77@gmail.com)

\*\*"Henri Coandă" Air Force Academy, Brasov, Romania

(marianpearsica@yahoo.com, lauriang@gmail.com)

DOI: 10.19062/1842-9238.2018.16.3.8

**Abstract:** *This paper presents a data mining procedure to generate a typical daily shape of energy consumption based on smart metering measurements. Such a typical daily shape describes an observed or estimated graphical representation of the variation of the electric load against time. This paper proposes two methods for the development of the novel data mining procedure: i) statistical analysis applied to a set of measured data; ii) cluster analysis using the machine-learning algorithm to determine a typical daily shape. The new procedure can be part of the Smart Metering and more precisely of the Automated Meter Reading (AMR). The results of the statistical analysis using the set of measured data show whether or not the average values are representative for the data set. The results of the cluster analysis extend the potential of forecasting a typical daily shape and of offering tools for potential applications to data mining procedure.*

**Keywords:** *Electrical energy load, statistical analysis, cluster analysis, data mining, typical daily shape, smart metering.*

### 1. INTRODUCTION

The implementation of smart grid concepts is inevitably linking distributed generation (DG), energy efficiency and storage. The element which forms the 'smart' core of the whole system is the internal capacity of the bidirectional flow management of both energy (due to the DG) and information, under the supervision and control of an intelligent control system.

Current Information and Communications Technology (ICT) methods to achieve the transmission, reception and processing of information enable the design of an intelligent network through which the exchange of information between all users of the electricity network is possible.

A key component of ICT-based smart grids is smart metering. The old-style meters are transformed into intelligent tools, interfaced with the data network, able to communicate with the data collection center of the distributor in order to transmit information on the detected energy consumption. Smart meters are divided into two categories:

i) Automated Meter Reading (AMR) systems, which implement simple functions of remote reading of energy consumption profiles, even in real time, from users and tariff profiles, thus leaving the human operation to cases of failure of the equipment and not to detection of consumption;

ii) Automated Meter Management (AMM) systems, which instead support bi-directional communication to the distribution utility and can thus improve and speed up the commercial services rendered to customers, perform self-diagnosis functions, signaling faults and power quality analysis in terms of interruptions, voltage variation and load measurement. In connection with the DG, some considerable synergies can also be obtained by using the smart meter communications infrastructure to remotely control the generators.

Several contributions to knowledge on energy load management and strategies for load profiling have recently been made. Al-Otaibi *et al.* [1] provide details about the construction and calibration for clustering of daily load curves from smart metering by applying a new method of a conditional filtering on meter resolution in order to obtain new consumption pattern recognition. Koivisto *et al.* perform an analysis with data from an AMR system.

Minchala-Avila *et al.* [2] present load profiles for consumers with renewable energy (wind, photovoltaic, energy storage) based on historical data, using the nonlinear model predictive control (NMPC) algorithm in islanding micro-grids. A variety of novel techniques, addressing and improving the problem of one-day-ahead load forecasting based on an interval type 2 fuzzy logic systems (IT2FLS), have been developed in paper [3]. Borges *et al.* [4] used aggregation for short-term load forecasting in Smart Grids using three methods: i) a bias correction, ii) top-down approach and iii) bottom-up approach and regression.

Cluster analysis has been employed in the literature for residential electrical load modeling [5]. The clustering was developed based on two models: i) a mixed model and ii) a Markov model for achieving group similarity. The time - use data model has been developed in paper [6] for the construction of load profile in residential electricity and hot-water demand use by assigning appliances to different categories of related activities.

McLoughlin *et al.* [7] described a methodological approach to electricity load profile characterization through a clustering model of a residential electricity load profile.

In all the articles presented, information solutions are distributed, using data mining for the concept of smart metering as well as different algorithms for the determination of load profiles, but they have not managed to propose fast solutions for their implementation involving all actors, distribution operators, equipment manufacturers and ultimately the consumer. Through the data mining procedure, to achieve the daily load curve proposed in this paper, we want to include the consumer as an active participant in the Smart Metering concept and ultimately make the quickest decisions on the free energy market.

## **2. DATA MINING FOR LOAD PROFILING**

The data mining procedure is summarized in FIG. 1. This shows the main steps to follow in view of building up the load profiling.

Starting from a data set at the pre-processing stage presented in section 3, a Statistical Analysis and a Cluster Analysis are performed in section 4. These are then merged into a Server Application, where a decision is made on the suitability of the curve. In case of a positive result, the typical load profile is constructed. Alternatively, the Load Forecasting approach/step is being followed.

### **A. Statistical analysis**

Statistical analysis allows the representation of data as diagrams, the calculation of specific quantities and reducing the amount of data by dividing it into classes and studying statistical characteristics of each of these.

Descriptive statistics is a tool that can characterize a sample  $X$  from population (where  $X$  is random variable) in the form of a data set of measurements  $\{x_i\}$ , where  $i = 1, 2, K, n$  [8], where  $n$  is number of items from sample  $X$ .

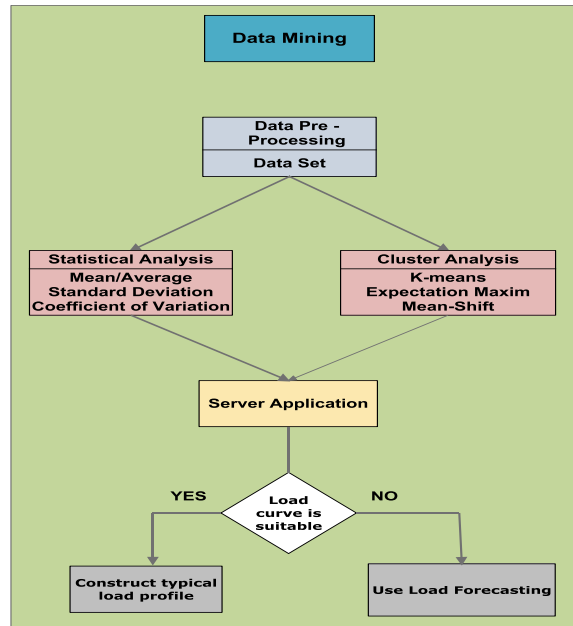

FIG. 1. Schematic representation of the data mining procedure

The mean (or expected value) of a data set of measurements  $\{x_i\}$ , where  $i = 1, 2, K, n$ , is defined by:

$$\mu_x = E(x) = \begin{cases} \frac{1}{n} \cdot \sum_{i=1}^n x_i; & x: \text{discrete} \\ \int_{-\infty}^{\infty} x \cdot f_x(x) dx; & x: \text{continuous} \end{cases} \quad (1)$$

where:  $f_x$  is the probability density function of the random variable.

The variance of a data sample from measurements  $\{x_i\}$ , where  $i = 1, 2, K, n$  is defined by:

$$\sigma_x^2 = Var(x) = \begin{cases} \frac{1}{n} \cdot \sum_{i=1}^n (x_i - \mu_x)^2; & x: \text{discrete} \\ \int_{-\infty}^{\infty} (x_i - \mu_x)^2 \cdot f_x(x) dx; & x: \text{continuous} \end{cases} \quad (2)$$

The standard deviation of a data sample from measurements  $\{x_i\}$ , where  $i = 1, 2, K, n$ , denoted by a  $\sigma_x$  is a positive square root of the variance shown in equation (2).

The coefficient of variation (CV), calculated as a percentage ratio between the standard deviation and the mean, is defined by:

$$CV_{\%} = \frac{\sigma_x}{\mu_x} \cdot 100 \quad (3)$$

The coefficient of variation enables the comparison of the scattering of data with different distributions for variables shown in different units.

In paper [9] the coefficient of variation is presented, considering the following thresholds and can be used as a significance test for the representativeness of the mean:

- $0 < CV \leq 17\%$  - the mean is strictly representative;
- $17\% < CV \leq 35\%$  - the mean is representative;
- $35\% < CV \leq 50\%$  - the mean is broadly representative;
- $50\% < CV$  - the mean is not representative.

In this paper, a procedure analysis is carried out with respect to the power consumption characteristic parameters using descriptive statistics, and experimental data are processed by applying statistical methods to a set of data obtained by smart metering for 6 months (May until October).

### **B. Cluster analysis**

A useful tool for identifying and predicting groups within data sets is cluster analysis. The work presented in paper [10] shows that the main purpose of clustering methods is to define the types of clusters; there are several established cluster analysis algorithms such as: two step clusters, K-Means clustering, Expectation Maximization (EM), and Mean-Shift.

The aim of the K-means algorithm is to divide  $M$  points in  $N$  dimensions into in a sample into  $k$  clusters ( $k < N$ ) so that each object belongs to the cluster with the nearest mean. There are multiple solutions for applying the K-means cluster algorithm, the simplest of them using special software tools. A number of software tools suitable for statistical processing are: Matlab, IBM SPSS, Weka, Statistica, OriginGraph, MedCalc. Paper [11] presents the algorithm of k-means clustering for the IBM SPSS software and was used for load profiling for a gas station with measurements data acquired over a period of one year. Paper [1] presents cluster analysis using K-means++, and the calculation was performed using the Matlab software.

In the current paper, the data mining procedure is performed using Statistica software, with tool cluster analysis. For this tool, the number of clusters introduced must be greater than 1 and less than the number of samples. Objects are placed in the cluster with the nearest mean at each iteration; following re-assignment of objects to clusters, the cluster mean is recalculated.

For quantitative data, the Euclidean distance used, denoted by  $d_{ij}$  between object  $i$  and cluster  $j$  is:

$$d_{ij} = \sqrt{\sum (x_i^{(j)} - x_j)^2} \quad (4)$$

where:  $x_i^{(j)}$  is data point from de cluster  $j$  and  $x_j$  is the center of the cluster  $j$ .

For obtaining some high tech and accurate models, the program users must have knowledge about the underlying modeling algorithms such as: forecasting, classification, segmentation and association detection. Current Automated Meter Management (AMM) systems lack a data mining procedure for load profiling and prediction in their smart metering component.

As it will be seen in the measurement data analysis Section 3, at present, because only components of Automated Meter Reading (AMR) exist, the measured data analysis takes a lot of time and the utilization of other software solutions and the utilization of data mining are mandatory.

### **C. Load forecasting**

As power use increases, so grows the importance of information regarding power consumption and generation.

Having information in advance regarding the power consumption makes it possible to schedule renewable energy generators such that they operate at the lowest possible cost. In order to have information in advance, there is a need for load forecasting. In order to achieve load forecasting, it is necessary to establish characteristics of data set through statistical analysis, to find similarities in all load curves and make clustering analysis for typical load profiles using information about the type of consumer and historical data.

Table 1 presents: the level of accuracy, data acquisition source and the method for calculating the load curve, as reported in literature table 2.

Table 1. Load curve method profiling

TYPE LOAD CURVE	ACCURACY	COST FOR OBTAINING DATA
Dynamic	<i>High</i>	Very High
Adjusted Static	<i>Medium-high</i>	High
Static	<i>Medium</i>	Medium
Similar	<i>Medium-low</i>	Medium
Net	<i>Low</i>	Low

Table 2. Load curve method profiling

TYPE LOAD CURVE	DATA SOURCE	METHOD
Dynamic	Electronic meter with load curve recording	ANNs , K-means, Wavelet - Fuzzy transform, VSTF
Adjusted Static	Historical database with meteorological factors	Long, medium, short-term load forecasting
Static	Historical measured data	Statistical
Similar	Less Historical measured data	Statistical
Net	System load curve mixed with electronic meter data <i>Low</i>	Statistical graphics

From Table 1, it can be noticed that the highest accuracy is achieved when profiling using the dynamic load curves based on data obtained at high cost, because a machine learning algorithm is used for this case. One of the challenges is to address similarity measures that are used to make clusters. Similar load curves are grouped together based on calculating similarity among load curves using similarity measures [12].

In paper [10] authors presented the similar load curve, these curves are constructed using historical data from similar days in the past. The clear advantages for this method are that is using less historical data and it takes account of meteorological data as show in Table 2. Net load curve this type of load curve uses also a unique curve for modeling consumers and captures one aspect of forecasting variability. The precision can become much higher if more electronic meters would be installed data as show in table 2.

In this work, static and dynamic profiling method will be used and then the k-means algorithm is chosen to construct the typical daily shape.

### 3. EXPERIMENTAL DATA ANALYSIS

#### A. Data set

The smart metering system installed in Romania has developed only the concept of AMR and uses different software, distinctive for each metering equipment producer. Typical data collected using the AMR systems for a commercial consumer are presented in Table 3. Only the data related to one working day and one non-working day were selected for representation. From the AMR system can be selected as electrical parameters: active and reactive power, active and reactive energy and power factor. Measurements can be displayed at 15 minutes, 30 minutes and 1 hour. To achieve case study the authors chose as the parameter the active power in kW.

Table 3. Measured data

Hour	kW	kW	Hour	kW	kW
1	24.89	28.89	13	41.36	38.1
2	25.59	28.3	14	47.24	34.24
3	25.5	25.88	15	33.93	27.29
4	24.31	25.92	16	34.51	31.34
5	22.24	25.04	17	38.67	28.28
6	24.54	26.02	18	38.09	27.95
7	25.35	24.27	19	34.06	24.49
8	26.75	28.82	20	40.77	31.23
9	21.37	30.61	21	53.37	25.52
10	24.54	26.03	22	37.78	26.92
11	33.16	29.27	23	34.41	30.29
12	41.27	37.71	24	26.55	32.49

In the process of creating load curves, some criteria must be taken into consideration; one of this is to select data from a working day (WD) and a non-working day (NWD). In the study presented in paper [13], the authors have performed an analysis of the daily diagram of the supply voltage for a working day and for a non-working day. The choice to perform the analysis separately for working days and for non-working days was made in order to obtain higher accuracy of the results.

**B. Data set analyses**

FIG. 3 shows the load curve for WD for 22 days over 24 hours for the month of May 2016 for a commercial consumer. The maximum value for WD in the month of May was 56.24 kW on the 30<sup>th</sup> May at 10.00 am and the minimum value was 19.24 kW on May the 24<sup>th</sup> at 10.00. As it can be observed in FIG. 3, it is difficult to identify curves with high similarity.

The data set analysis is useful both statistically and with respect to clustering as it provides an overall picture of the power consumed and the energy needed from renewable energy sources.

FIG. 4 shows the graphical representation of the mean values from table 2. We can notice that the curve represented in FIG. 4 has two peaks, which are very important when one wants to buy energy on the electricity market. Also, from FIG. 4 it can be observed that the values of the minimum and maximum averages are similar to those in FIG. 3 representing the load curves for working days in the month of May.

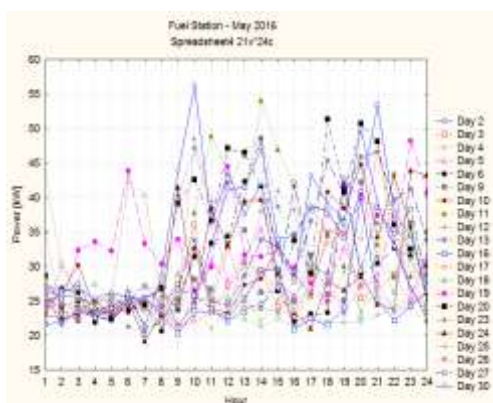

**FIG. 3.** Load curve for the month of May 2016

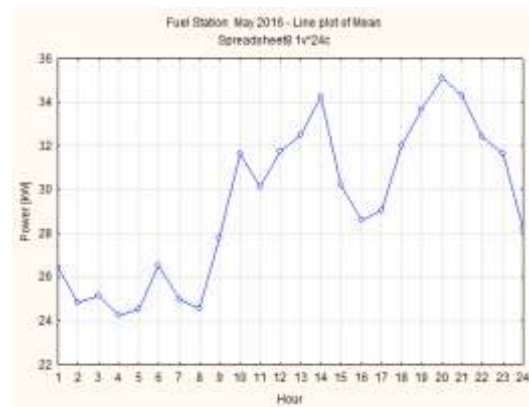

**FIG. 4.** Load curve with mean values

Using equations 1-3, table 4 presents the statistical analysis (minimum, mean maximum, standard deviation and coefficient of variation) for all WDs in the month of May 2016.

According to Section 2, the maximum value of the coefficient of variation is 30.12 % at 10.00 am; this means that the parameter mean is slightly representative.

Table 4. Statistical analysis for WD in month May

Hour	Min [kW]	Mean [kW]	Max [kW]	Standard deviation	Coefficient of variation [%]	Hour	Min [kW]	Mean [kW]	Max [kW]	Standard deviation	Coefficient of variation [%]
1	21.54	26.33	43.66	4.78	18.15	13	22.31	33.45	53.42	8.65	25.87
2	21.50	24.76	30.53	2.30	9.29	14	21.27	34.71	54.08	9.83	28.32
3	22.12	25.10	32.30	2.47	9.83	15	22.46	30.11	46.93	6.00	19.92
4	21.87	24.21	33.56	2.42	10.00	16	20.89	28.94	42.09	6.59	22.79
5	22.24	24.49	32.16	2.11	8.60	17	21.07	28.98	43.21	5.67	19.57
6	21.21	26.40	43.85	5.50	20.83	18	19.41	31.43	51.31	8.26	26.27
7	19.17	24.78	40.20	4.58	18.50	19	21.87	33.33	42.62	6.58	19.73
8	20.57	24.92	32.49	2.89	11.59	20	21.91	34.81	50.67	9.32	26.78
9	20.27	28.28	43.71	7.51	26.57	21	22.90	34.39	53.37	8.36	24.31
10	22.01	31.53	56.24	9.50	30.12	22	22.14	32.20	43.47	6.55	20.34
11	21.01	30.58	48.91	7.42	24.25	23	24.01	31.46	48.22	6.91	21.97
12	21.94	31.84	47.07	8.42	26.45	24	21.86	28.01	43.16	5.82	20.77

## 5. SIMULATION AND RESULTS

In order to perform the simulation, the data set was divided into two categories: WD and NWD, in the period from May 2016 until October 2016. Using the Statistica software, the cluster analysis with the k-means algorithm was performed. The data set used as input into the Statistica software package was all WD and NWD in the period from May 2016 until October 2016.

The decision to select this particular period of 6 months is based on the fact that in Romania the peak electricity consumption has moved from the winter months into the summer months. This is due to the preferential use of natural gas for heating (relevant mostly to winter months) versus the use of electricity for cooling (through the use of air-conditioning units) in the summer months.

Table 5 shows the statistical analyses for mean values of each month for all WDs in a 6 months period. The coefficient of variation has many values lower than 17%; therefore, the mean (average) for 6 month is representative and can be used as cluster mean. FIG. 5 shows the details of the statistical graphs using Box plots for mean (average) on 6 months. This diagram, referring to the results of Table 5, aims to achieve a qualitative data representation by summarizing the five statistical parameters: maximum, minimum, average, median and standard deviation.

In FIG. 5 it can be observed that, for the period analyzed, the lowest WD consumption is in the month of July and the highest is in September. Generally, the load variation was achieved in the summer months.

Table 6 shows the statistical analysis of the mean values of each month for all NWDs in a 6 months period.

Table 5. Statistical analyses for values of means for WD

WD	Mean May	Mean June	Mean July	Mean Aug.	Mean Sept.	Mean Oct.	Mean 6 Month	Coefficient of variation
[H]	[kW]	[kW]	[kW]	[kW]	[kW]	[kW]	[kW]	[%]
1	26.33	30.17	26.40	25.78	26.30	29.14	27.35	4.68
2	24.76	27.18	25.20	25.74	24.25	28.31	25.91	2.88
3	25.10	25.32	25.19	25.56	23.81	28.69	25.61	5.49
4	24.21	24.08	24.13	24.64	24.30	29.62	25.16	5.31
5	24.49	23.59	24.52	24.78	24.76	29.26	25.23	8.52
6	26.40	23.89	24.29	24.90	24.32	29.61	25.57	7.88
7	24.78	24.48	25.14	25.56	25.94	31.09	26.16	12.56
8	24.92	24.48	22.94	25.09	26.57	30.43	25.74	7.05
9	28.28	23.68	27.05	26.31	26.62	34.85	27.80	13.27
10	31.53	26.94	30.00	31.06	31.98	40.05	31.93	19.22
11	30.58	34.13	32.40	33.82	33.56	40.15	34.11	8.01
12	31.84	33.30	34.60	36.78	35.07	37.85	34.91	11.16
13	33.45	35.35	36.05	36.11	35.20	36.22	35.40	6.03
14	34.71	36.23	37.34	37.42	37.37	41.24	37.38	7.95
15	30.11	38.13	37.70	37.12	37.27	39.72	36.67	11.36
16	28.94	38.27	39.56	36.91	36.57	40.69	36.82	12.55
17	28.98	36.92	36.34	38.23	36.89	36.29	35.61	9.88
18	31.43	35.48	40.04	35.84	39.29	35.52	36.27	12.19
19	33.33	36.74	37.78	36.93	37.99	39.09	36.98	3.73
20	34.81	34.59	41.56	40.96	38.85	40.72	38.58	12.05
21	34.39	40.72	40.57	40.52	44.08	40.13	40.07	11.02
22	32.20	37.76	37.55	37.18	36.55	35.55	36.13	3.49
23	31.46	38.49	36.65	31.53	32.64	30.64	33.57	10.72
24	28.01	35.19	32.18	29.30	29.65	28.22	30.43	7.28

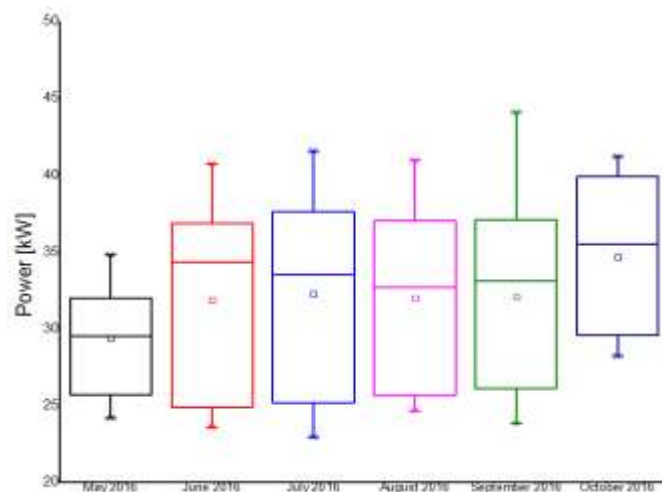

FIG. 5. Statistical graphics with Box plots for WD



Table 6. Statistical analyses for values of means for NWD

NWD	Mean May	Mean June	Mean July	Mean Aug.	Mean Sept.	Mean Oct.	Mean 6 Month	Coefficient of variation
[H]	[kW]	[kW]	[kW]	[kW]	[kW]	[kW]	[kW]	[%]
1	26.33	30.17	26.40	25.78	26.30	29.14	27.35	4.68
2	24.76	27.18	25.20	25.74	24.25	28.31	25.91	2.88
3	25.10	25.32	25.19	25.56	23.81	28.69	25.61	5.49
4	24.21	24.08	24.13	24.64	24.30	29.62	25.16	5.31
5	24.49	23.59	24.52	24.78	24.76	29.26	25.23	8.52
6	26.40	23.89	24.29	24.90	24.32	29.61	25.57	7.88
7	24.78	24.48	25.14	25.56	25.94	31.09	26.16	12.56
8	24.92	24.48	22.94	25.09	26.57	30.43	25.74	7.05
9	28.28	23.68	27.05	26.31	26.62	34.85	27.80	13.27
10	31.53	26.94	30.00	31.06	31.98	40.05	31.93	19.22
11	30.58	34.13	32.40	33.82	33.56	40.15	34.11	8.01
12	31.84	33.30	34.60	36.78	35.07	37.85	34.91	11.16
13	33.45	35.35	36.05	36.11	35.20	36.22	35.40	6.03
14	34.71	36.23	37.34	37.42	37.37	41.24	37.38	7.95
15	30.11	38.13	37.70	37.12	37.27	39.72	36.67	11.36
16	28.94	38.27	39.56	36.91	36.57	40.69	36.82	12.55
17	28.98	36.92	36.34	38.23	36.89	36.29	35.61	9.88
18	31.43	35.48	40.04	35.84	39.29	35.52	36.27	12.19
19	33.33	36.74	37.78	36.93	37.99	39.09	36.98	3.73
20	34.81	34.59	41.56	40.96	38.85	40.72	38.58	12.05
21	34.39	40.72	40.57	40.52	44.08	40.13	40.07	11.02
22	32.20	37.76	37.55	37.18	36.55	35.55	36.13	3.49
23	31.46	38.49	36.65	31.53	32.64	30.64	33.57	10.72
24	28.01	35.19	32.18	29.30	29.65	28.22	30.43	7.28

The statistical graphs using Box plots for mean (average) for a 6 months period for NWD is shown in FIG. 6. This shows that for the period analyzed, the lowest NWD consumption was in the month of September, whereas the highest relates to the month of June.

Due to the high variability of the load, the second stage of the data mining, the cluster analysis, is considered as a prediction of future typical daily shapes. Such information is useful for all the participants in the energy market as it shows the peaks and dips related to the next day, as resulting from the cluster analysis calculations using the Statistica software package, based on the k-means algorithm. The number of clusters is set to 2 and the number of iterations is set to a maximum of 10.

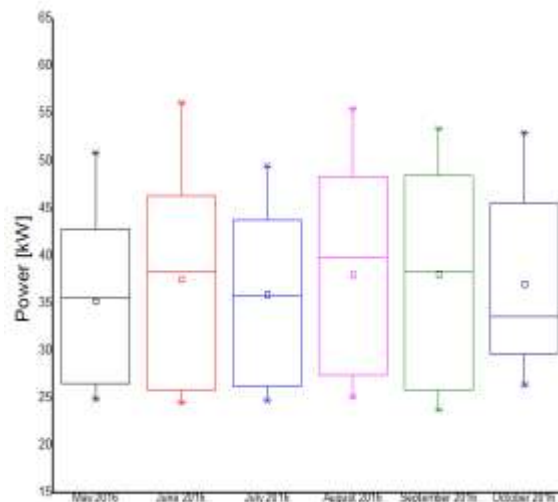

FIG. 6. Statistical graphics with Boxplots for NWD

Table 7 shows the result for cluster analysis with mean (average) for WD in 6 months. In the data mining process, the software Statistica has put in cluster 1 higher values and in cluster 2 lower values.

Using statistical analysis, the mean (average) for WD was verified. The data mining procedure was applied and the mean values can be used for energy load management and price forecasting as typical daily shapes.

Table 7. Results for clustering analyses and means for WD

Hour	Cluster 1	Average	Cluster 2	Hour	Cluster 1	Average	Cluster 2
1	28.77	27.36	25.91	13	41.10	35.26	29.22
2	26.94	25.91	24.86	14	44.53	37.30	29.85
3	26.25	25.61	24.95	15	43.80	36.72	29.41
4	25.60	25.14	24.67	16	43.24	36.78	30.11
5	25.87	25.22	24.54	17	42.34	35.68	28.82
6	25.70	25.56	25.41	18	41.81	36.37	30.75
7	26.68	26.17	25.65	19	42.22	37.04	31.69
8	26.23	25.67	25.09	20	43.95	38.64	33.17
9	29.50	27.66	25.76	21	46.74	40.09	33.24
10	35.84	31.89	27.82	22	41.40	36.20	30.82
11	39.34	34.02	28.54	23	36.70	33.60	30.40
12	40.99	34.91	28.64	24	32.93	30.47	27.93

The values for clusters and mean (average) for NWD over 6 months are shown in table 8.

Table 8. Results for clustering analyses and means for NWD

Hour	Cluster 1	Average	Cluster 2	Hour	Cluster 1	Average	Cluster 2
1	29.12	28.47	28.40	13	50.88	47.83	47.60
2	26.36	26.70	26.70	14	52.60	49.11	48.91
3	26.10	26.15	26.14	15	54.59	50.51	50.33
4	25.54	25.25	25.31	16	52.82	47.92	47.77
5	25.65	25.87	25.88	17	50.64	46.69	46.54
6	25.88	26.26	26.37	18	50.21	45.87	45.89
7	25.96	26.08	26.10	19	49.40	45.63	45.52
8	26.65	26.37	26.48	20	47.06	43.90	43.77
9	30.03	28.84	28.95	21	45.34	42.36	42.16
10	38.66	36.09	35.96	22	42.78	40.62	40.36
11	43.55	40.00	39.96	23	33.82	33.41	33.32
12	51.17	46.88	46.70	24	31.00	30.55	30.64

The curves corresponding to the data shown in table 7 are represented using 3D graphics in FIG. 7. The mean (average) for NWDs can be used as typical daily shape. FIG. 8 shows the 3D graphics for the data set values in table 8.

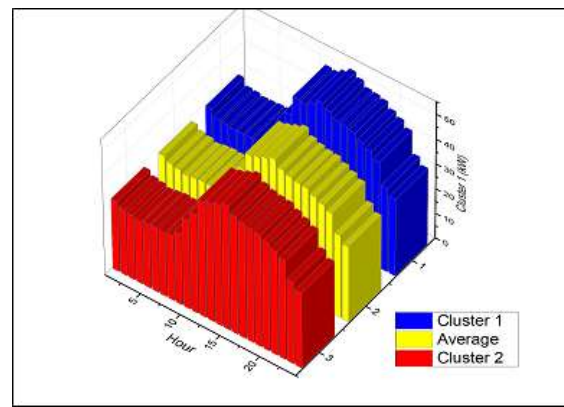
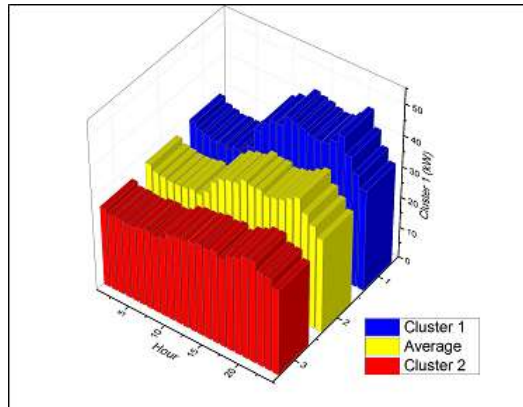

**FIG. 7.** The 3D graphics for cluster and mean in WD **FIG. 8.** The 3D graphics for cluster and mean in NWD

It was necessary to use a two weeks time frame in order to perform this analysis because component AMR does not have the possibility to arrange and to format data, so in order to prepare the data set, several attempts were necessary. With our proposed method of data mining for a typical daily shape, the AMR system can easily be implemented into intelligent metering systems as solution for smart metering.

## 5. CONCLUSIONS

The data set achieved through the Automated Meter Management (AMM) system is the most important part in Smart Metering for electrical energy consumption patterns. The current paper presented a data mining procedure for generating typical daily shapes, designed and tested for a commercial consumer.

From the commercial consumer statistical analysis accomplished, it results that the first stage of the data mining procedure introduces only the average standard deviation parameters and standard deviation to indicate whether the average is representative for the data set analyzed, these parameters being easy to interpret for all actors involved in smart metering.

The second stage of the data mining procedure includes the cluster analysis using an automated learning algorithm, necessary for generating typical daily shapes. This analysis requires the use of specific software which makes it troublesome for some of the users who need to familiarize themselves with these tools.

By using the statistical programs through the k-means clustering algorithm analysis, the production of typical daily shapes was achieved with the commercial consumer, and, as a result, the average values of the data set for the six-month period under analysis may be used as typical daily shapes.

For the case when the average values are different from the accomplished clusters, the analysis is performed again using algorithms for load forecasting. The main advantage of this procedure is that it uses a mathematical apparatus which is easy to understand by all actors involved in energy load management and price forecasting in order to support the concept of Smart Grids. For energy load management and price forecasting, this procedure brings the market actors closer to the final consumer, by offering the possibility of holding information related to the financial management of the energy consumed or produced in Smart Grids.

## REFERENCES

- [1] R. Al-Otaibi, N. Jin, T. Wilcox and P. Flach, Feature Construction and Calibration for Clustering Daily Load Curves from Smart-Meter Data, *IEEE Transactions on Industrial Informatics*, vol. 12, no. 2, pp. 645-654, April 2016.
- [2] L. I. Minchala-Avila, L. Garza-Castañón, Y. Zhang and H. J. A. Ferrer, Optimal Energy Management for Stable Operation of an Islanded Microgrid, *IEEE Transactions on Industrial Informatics*, vol. 12, no. 4, pp. 1361-1370, Aug. 2016.
- [3] A. Khosravi and S. Nahavandi, Load Forecasting Using Interval Type-2 Fuzzy Logic Systems: Optimal Type Reduction, *IEEE Transactions on Industrial Informatics*, vol. 10, no. 2, pp. 1055-1063, May 2014.
- [4] C. E. Borges, Y. K. Peña and I. Fernández, Evaluating Combined Load Forecasting in Large Power Systems and Smart Grids, *IEEE Transactions on Industrial Informatics*, vol. 9, no. 3, pp. 1570-1577, Aug. 2013.
- [5] W. Labeeuw and G. Deconinck, Residential Electrical Load Model Based on Mixture Model Clustering and Markov Models, *IEEE Transactions on Industrial Informatics*, vol. 9, no. 3, pp. 1561-1569, Aug. 2013.
- [6] J. Widén, M. Lundh, I. Vassileva, E. Dahlquist, K. Ellegård, E. Wäckelgård, Constructing load profiles for household electricity and hot water from time-use data-Modeling approach and validation, *Energy and Buildings* 41, no. 7, pp. 753-768, 2009.
- [7] F. McLoughlin, A. Duffy, M. Conlon, A clustering approach to domestic electricity load profile characterization using smart metering data, *Applied energy*, 141, pp.190-199, 2015.
- [8] C. Mihai, E. Helerea, L. Sângerzan, Characterization of voltage variations through the application of experimental statistics, *International Conference on Optimization of Electrical and Electronic Equipment (OPTIM)*, Bran, pp. 198-203, 2014.
- [9] C. Mihai, I. Lepadat, E. Helerea, D. Calin, Load curve analysis for an industrial consumer, *12th International Conference on Optimization of Electrical and Electronic Equipment*, Basov, pp. 1275-1280, 2010.
- [10] C. Mihai, D. Ilea, P. M. Mircea, Use of load profile curves for the energy market, *International Conference on Development and Application Systems (DAS)*, Suceava, 2016, pp. 63-70, 2016.
- [11] C. Mihai, C. Popa, P. M. Mircea, Load profiling for gas stations using cluster techniques, *IEEE International Power Electronics and Motion Control Conference (PEMC)*, Varna, Bulgaria, pp. 1041-1048, 2016.
- [12] T. Teeraratkul, D. O'Neill, S. Lall, Shape-Based Approach to Household Load Curve Clustering and Prediction. arXiv preprint arXiv:1702.01414, 2017.
- [13] B. Dolník, Contribution to analysis of daily diagram of supply voltage in low voltage network: Working days versus non-working days, *2015 16th International Scientific Conference on Electric Power Engineering (EPE)*, Kouty and Desnou, 2015, pp. 373-376.

## SDR SYSTEM FOR GNSS SIGNAL PROCESSING

Larisa MONACU, Titus BĂLAN

Transilvania University, Brasov, Romania  
(larisa.monacu@student.unibv.ro , titus.balan@unitbv.ro )

DOI: 10.19062/1842-9238.2018.16.3.9

**Abstract:** *Commercially available GNSS (Global Navigation Satellite System) receivers, where signal processing is done on the hardware side, are limited in terms of search frequency, PLL phase, noise bandwidth, or algorithms used to process the input GNSS signal and are not suitable for utilization in industrial or military applications. Thus, the most reliable solution is the usage of a software-configurable receiver. Satellite navigation allows accurate location services in vehicle, air and naval navigation systems But its precision can also be used in military services like delivering weapons to targets for military purposes, or in other applications in the IoT domain or people tracking services. This paper describes the implementation of real-time GNSS reception in the L1 band using Software Defined Radio (SDR) platforms and specific software implementations for signal processing, aiming to obtain a precise geographic position, as well as a method for the broadcasting of GNSS signals based on the SDR platform.*

**Keywords:** *SDR, GPS, Real Time tracking, GPS Spoofing, IoT*

### 1. INTRODUCTION

Finding position and location has remained a source of interest for the industry, which is trying to improve the quality and precision of location services. In the past, people have explored stellar constellations to establish their position. Since the US implementation of the GPS system and a similar GLONASS system by the Soviet Union, satellite positioning applications have grown globally, not only in the military area but also in the commercial market. Aircraft and ships use the GPS system to find out the current position and guide them to the destination without hitting obstacles. Farmers also use the GPS system for automatic farming equipment to ensure that they plant in the same place in the next season. Topography field uses GPS to analyze different surfaces of the earth. Telecommunications use GPS for social activities, including cross-country cycling, skiing, hiking skydiving, paragliding, geotagging photographs among others.

This paper describes the implementation of real-time GNSS reception in the L1 band, using the Hack RF One SDR platform, along with an ANT555 GPS antenna which processes the signal to obtain the geographic position.

The Global Navigation Satellite System GNSS is defined as a satellite system that provides the autonomous geo-spatial position with a global approach. GNSS receivers using GPS, GLONASS, Galileo, or BeiDou systems are used in many applications.

The US implementation, the GPS system, is a radio navigation and positioning system that provides accurate information about the position, speed and timing of the information to the GPS receiver. The NAVSTAR GPS system was launched in 1974 and since 1983 GPS has been used also for civil purposes.

The system functions based on the usage of minimum three GPS satellite signals, used to calculate position, speed and time information for users.

Accuracy of GPS determination can range from tens of meters to millimeters, depending on the equipment and method used.

The operating principle of the GPS antenna consists in the measurement of the signal propagation time between the satellites and a terrestrial receiver, thus determining the receiver's position. Software Defined Radio (SDR) technology grew between 1990-1995 with the SPEAK Easy Military Program, which aimed to build a US Air Force radio that could operate at frequencies between 2MHz and 2GHz.[1]

Software Defined Radio systems have parameters that can be reconfigured via software. In its original academic term, the term software radio refers to the reconfiguration of the radio interface through software, comprising reconfigurability at any OSI level through software. The concept has been introduced to migrate hardware components such as mixers, filters, amplifiers, modulators/demodulators, detectors, software to a personal computer, or an embedded architecture.[2]

SDR technology, applied to global satellite navigation (GNSS) reception, allows the implementation of a positioning device with a high level of flexibility. Hardware design is generally very costly and any significant improvements require a redesign of the hardware. Compared to a conventional GNSS hardware receiver, the use of an SDR provides greater flexibility for processing and analyzing in intermediate stage signals. Furthermore, a software receiver can also be configured as a GNSS multi-constellation receiver with small modifications. The SDR implementations, used in many domains, were also tailored for GNSS receiving platforms and analyzed in several research papers [3],[4],[5],[6].

In this paper, besides the usage of the multipurpose Hack RF One SDR hardware platform, we have used the GNSS-SDR software reception framework that provides implementation of various algorithms required by a GNSS receiver, from reading the first probe to conditioning and passing it through competing blocks that affect acquisition, coding and tracking phases, as well as demodulation of the signal. Having everything implemented in software brings two main advantages: first, the GNSS SDR receiver can be easily upgraded during its operational life, second, the SDR platform can be used for prototyping different signal processing and signal quality monitoring algorithms.

A Software Defined Radio platform can be used not only to accurately receive GNSS signals, but also to emulate GNSS signals and to transmit them, as a method for spoofing unauthorized access of devices that are navigating based on GNSS coordinates.

This paper is organized as follows: subsection 2 introduces the software and hardware elements used for our experimental platform, subsection 3 detail the blocks needed for signal processing, subsection 4 shows a way for results validation and visualization while subsection 5 details a method for GPS Spoofing using an SDR element, with possible military applicability.

## **2. SDR PLATFORM ELEMENTS**

As software platform for the signal receiving and for the extraction of the geographical position we have used a GNSS-SDR platform that implements a software defined receiver with the help of C++ defined functions. GNSS-SDR is based on GNU Radio, a well-known framework that provides signal processing and processing blocks that can be used in a visually programmatic way. GNSS-SDR provides an easy code, completely reusable for RF fronts, and allows new implementation or personalization. It offers interfaces to all type of RF signals for different hardware SDR platforms.[7]

From the satellite positioning point of view, GNSS-SDR runs a C++ program that reads data from a signal source (that can be a hardware device or a suitable prerecorded file) and which performs all signal processing until the geographical position is established.

We have run the software configurations in the software of a personal computer running Linux. As we have mentioned, for the “dry run” tests, to ensure that the system is working properly on the PC environment, we have used the option to process samples of raw data stored in a file, as we wanted to be sure that the system is not influenced by the real-time processing time constraints.

GNSS SDR provides interfaces through USB and Ethernet buses to a variety of commercially or customized front-ends by adapting processing algorithms to different sampling frequencies, intermediate frequencies, and sample rates [8].

We had several options to be used as hardware SDR platform for the effective data acquisition: USRP products from Ettus Research (National Instruments) that supports a wide variety of development environments for RF applications [9], Digilent Zedboard platform, based on the Xilinx Zynq that includes a processing system and a programmable logical layer with connection to a RF daughterboard from Analog Devices [10] and Hack RF from Great Scott Gadgets capable of transmitting or receiving radio signals from 1 MHz to 6 GHz

After analyzing the hardware contained in various devices designed to demodulate the signals, we have chosen to use the Hack RF One due to its lower costs and simpler use than other products. It is recommended to install and use the device within the Linux distribution, which offers a wider range of continuously developing libraries.

Designed to enable the testing and development of the latest and next-generation technologies, Hack RF One is a hardware platform that can be used as an USB peripheral or programmed for autonomous operation and has the ability to digitize received or transmitted radio signals.[11]

### 3. GPS RECEPTION AND SIGNAL PROCESSING

After we have validated the software functionality by using pre-recorder satellite data, we have moved to the real solution so the SDR receiver is processing real-time GNSS signals. We have obtained the reception of GPS signal from the L1 Band, centered on 1.57542 MHz using the Hack RF ONE device, an ANT555 GPS antenna specific for GPS L1 signal reception and a software configuration file made using the GNSS-SDR implementation blocks.

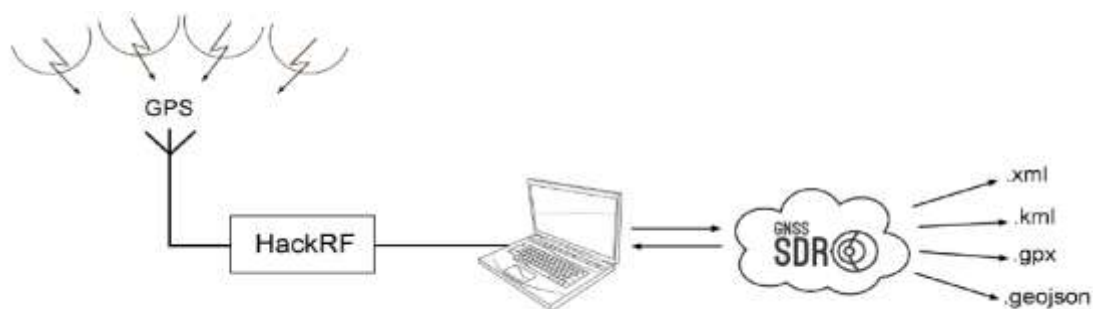

**FIG.1** The block diagram for real-time GPS reception

Initially, we aimed to receive the L1 C / A GPS signal with the VERT2450 antenna, which has a bandwidth of up to 5.6 GHz. In order to receive and decode a GPS signal, a specific GPS antenna, which operates in the 1.5 GHz band, is required. It is also necessary for the antenna to have a built-in LNA amplifier to amplify the signal due to the losses, or an external amplifier connected between the antenna and the device. So we chose to use the ANT555 GPS antenna.

If one cannot track and acquire the signal, the terminal displaying "loss of lock in channel x", a parameter to be reconfigured is the one referring to the Doppler Effect. In this sense, the value of the Doppler parameter in Hz should be increased and the search step in the frequency grid decreased.

The software configuration performs the acquisition and tracking of the signal, decodes the navigation message and other variables required for the positioning algorithms, finally calculating the navigation solution.

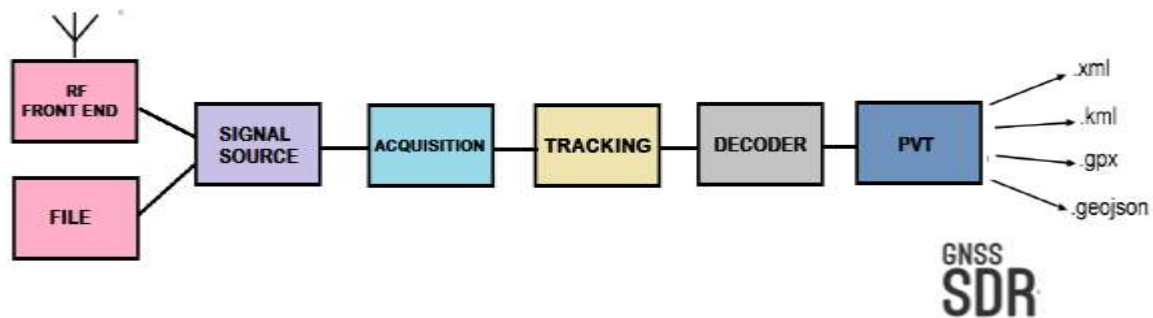

FIG.2 Block diagram describing the GNSS-SDR operation

Main functional blocks used for signal processing are described below:

- SIGNAL SOURCE

The signal source block is responsible for implementing the hardware driver, that communicates with the Hack RF One device and injects a continuous stream of raw GNSS signal samples into the processing flow graph. Inputs are the raw bits that come out of the analog-to-digital converter (ADC) of the Hack RF One, being read in real time with the ANT555 GPS ANTENNA. Also, the signal source may be a file that contains previously recorded signal rows, real or simulated.

- ACQUISITION

It contains blocks to convert the data type into the sample stream, to filter the noise and possible interference and to transmit the input data.

- TRACKING

The role of a tracking block is to track the evolution of the signal synchronization parameters: encoding phase, Doppler effect, and operator phase.

- DECODER

The role of the block is to get the data bits from the navigation message broadcast by GNSS satellites. The NAV GPS message is modulated at 50 bits / second. The entire message contains 25 frames of 30 seconds, forming the main frame. Each frame is divided into 5 sub-frames of 6 seconds each. Also, there are collected sync data from all processing channels in order to calculate GNSS fundamental measurements: pseudodistance, carrier phase and Doppler effect.

- POSITION- VELOCITY -TIME



The role of a PVT block is to calculate navigation solutions and provide information in appropriate formats for further processing or representation of data for geographic information: .KML, .GeoJSON, .XML and .GPX files are generated when calculating the first fixed position.

#### 4. THE RESULTS OF POSITIONING SYSTEMS

Receiving the signal should be done in open spaces, preferably on a high building, to avoid interference and reflection introduced by the environment where the signal is propagated. Satellite signals do not propagate through the walls of the buildings or the foliage of the forests (trees), so the antenna must have direct view to the sky.

In the Linux terminal, after setting the configuration files and initiating the configuration, satellites were detected for the number of channels set. After a few seconds of the L1 C / A GPS signal has been detected, navigation messages were received for each channel. To decode the location, it is necessary to receive the signal from at least four satellites. After approximately 10 seconds of signal acquisition and tracking, real-time location determination and coordinate display in the terminal were performed.

The advantage of using GNSS-SDR is the ability to generate .xml, .kml, .geojson, .gpx files that contain the coordinates. These files can be opened with the help of appropriate tools to verify the correct location and determine the accuracy of the geographic position. For example, we have opened the resulting .kml file with the Google Earth application.



**FIG.3** Viewing real-time geographic location in Google Earth application

We have observed in our tests that the method used provides a 3-4 meter accuracy of user location, which is a pretty good estimate given the weather conditions and the reflections on the surrounding buildings at the moment of receiving the data.

Also the coordinates resulting from the decoding of the location can be transmitted in a cloud or a data base over the internet for further processing or monitoring and thus accessible at all times. Stored data can be used in IoT applications, such as tracking services for people, vehicles or devices.

## 5. GPS SPOOFING WITH APPLICABILITY IN THE MILITARY DOMAIN

Another way to use the SDR platform is not only to receive GNSS signals, but also to transmit GNSS signals, emulating a real GNSS system. A GPS spoofing attempts to deceive a GPS receiver by broadcasting incorrect GPS signals, structured to resemble a set of real GPS signals. In case of protecting critical infrastructures against unauthorized unmanned vehicles, like drones, that navigate based on GNSS positioning, the GPS spoofing is a valid countermeasure.

We have used the SDR platform to simulate a GPS signal from the L1 band (C / A data) using a script [12] based on a file containing ephemeris GPS data to specify the GPS satellite constellation. The ephemeris data file is available to the public, updated daily on the site: <http://cddis.gsfc.nasa.gov/>

These files are then used to generate simulated pseudo-distance and Doppler effect for GPS satellites in view, and then used to generate digital I / O samples to simulate the L1 C / A GPS signal. To obtain the simulated GPS signal, a file containing the modified data is generated

To test that the broadcasted GPS signal is received by surrounding elements, we used the Android GPS Test application, available for free, with which can display the signals from different available satellites and the current location of the user. The simulated GPS signal was transmitted using the Hack RF One device and a VERT2450 antenna. After a few tens of seconds, we were able to receive the data transmitted using the fake broadcast signal.

In order to receive the new signal, it is necessary to set the Location Mode - GPS Only and to restart the smartphone to correctly apply the setting. Otherwise, the mobile device will estimate the geographic position using the Internet.



FIG.4 View of the fake data received by the GPS Test application

FIG. 4 shows the reception of the simulated GPS signal, the reception power for each simulated satellite and the accuracy with which the location was calculated (on the left side). It also shows the coordinates of the current location received by the mobile device, the coordinates that were specified when creating the transmitted file, as well as its positioning on a map. The current time is different from the time displayed by the GPS Test application as the time at which the processed ephemeris data was processed.

The development of the GPS application system by the US Defense Department led to the use of the system as a defense mechanism during the war. Today, military applications have grown to be used in the mapping of missile location or equipment, monitoring of areas of military interest, guiding soldiers in reconnaissance or rescue operations. GPS Spoofing can be used in falsely guiding enemy equipment in case of war or deviation of airplanes and ships to other targets or strategic locations.[13]

## 6. CONCLUSIONS

This paper presents a method for real-time GNSS signal reception from the NAVSTAR GPS system via a Software Defined Radio platform. The received data is processed using the implemented software blocks from GNSS-SDR in order to obtain the real-time geographic position of the receiver. A software reception system has more flexibility compared to the conventional off-the-shelf hardware receiver because intermediate signals are available for processing and analysis at each stage.

Real-time reception using the GPS antenna and the Hack RF SDR platform with GNSS-SDR software configuration was tested to provide a 3-4 meter accuracy of user location. New algorithms can be added and tested in the modular structure of the software receiver.

The paper also describes a way of simulating the GPS signal in order to obtain a fictive geographic position and user data, by transmitting using the SDR platform of a file which contains a set of fake coordinates, usable in defense scenarios based on GPS spoofing.

The use of a common radio platform for multiple markets, significantly reduces the logistical support and operating expenditure. In the high-performance military and government communications market, radio system designers and integrators are often incorporating SDR elements, that allow for the addition of new features and capabilities without requiring major new infrastructure expenditures.

## REFERENCES

- [1] O. Croitoru, *Terrestrial and Space Radiocommunications*, Chapter 14, Transilvania University of Brasov, 2018
- [2] About SDR <http://www.rtl-sdr.com/about-rtl-sdr/>, accessed on 22 October 2018
- [3] H. Heikki, R. Jussi, A. Tapani, N. Jari, *Multicore software-defined radio architecture for GNSS receiver signal processing*, Published in journal: *EURASIP Journal on Embedded Systems - Special issue on design and architectures for signal and image processing archive*, Volume 2009
- [4] A. Brown, J. Redd and M.-A. Hutton, *Simulating GPS Signals: It Doesn't Have to Be Expensive*, *GPS World*, Vol. 23, No. 5, May 2012
- [5] M. Rao, G. Falco, *SDR Joint GPS/Galileo Receiver from Theory to Practice*, *International Journal of Aerospace Sciences* 2012, 1(1): 1-7
- [6] T. Pany, N. Falk, B. Riedl, T. Hartmann, G. Stangl, and C. Stöber, *Software GNSS Receiver: An Answer for Precise Positioning Research in GPS World*, Vol. 23, No. 9, September 2012
- [7] GNSS-SDR:  
[https://www.researchgate.net/publication/233380791\\_GNSS\\_SDR\\_An\\_open\\_source\\_tool\\_for\\_researchers\\_and\\_developers](https://www.researchgate.net/publication/233380791_GNSS_SDR_An_open_source_tool_for_researchers_and_developers)
- [8] About GNSS-SDR <https://gnss-sdr.org/docs/>, accessed on 22 October 2018
- [9] A. Marwanto, M. Sarijari, A. Fisal, N. Yusof, R. Rashid, (2009, December). *Experimental study of OFDM implementation utilizing GNU Radio and USRP-SDR in communications (MICC)*, 2009 IEEE 9th Malaysia International Conference on (pp. 132-135). IEEE.
- [10] S. Gvozdenovic, *System Level Design of Software-Defined Radio Platform* <https://digitalcommons.wpi.edu/cgi/viewcontent.cgi?article=4152&context=mqp-all>
- [11] About HACKRF ONE <https://greatscottgadgets.com/hackrf/> accessed on 22 October 2018
- [12] Script created by Takuji Ebinuma available at <https://github.com/osqzss/gps-sdr-sim>

- [13] D. P. Shepard, J. A. Bhatti, and T. E. Humphreys, *Unmanned Aircraft Capture and Control via GPS Spoofing*, <https://pdfs.semanticscholar.org/c9d8/5878c56390b614a891d477b90d1b35ceb21b.pdf>
- [14] L. Presti, L. di Torino, P. Falletti, E. Nicola, M. M. Gamba., *Software defined radio technology for GNSS receivers*, (2014, May).
- [15] M. Z. H. Bhuiyan, S. Söderholm, S. Thombre, L. Ruotsalainen, H. Kuusniemi, *A multi-GNSS software-defined receiver: design, implementation, and performance benefits*, 2016, ed. Spring
- [16] T. Pany, *Navigation signal processing for GNSS software receivers*, 2010, Artech House.
- [17] M. H. S Malik, M. A Malik, U. I. Bhatti, M. S. Z Farooq, M. Iqbal, *Global Navigation Satellite System Software Defined Radio*, 2014
- [18] A. S. H. Ghadam, M. Renfors, B. Soltanian, *Utilization of multi-rate signal processing for GNSS-SDR receivers*, 2014, ed. Spring
- [19] T. Ren, M. Petovello, *An analysis of maximum likelihood estimation method for bit synchronization and decoding of GPS L1 C/A signals*, Ed Spring 2014
- [20] M. Pini, E. Falletti, M. Fantino, *Performance evaluation of C/N0 estimators using a real time GNSS software receiver. In Spread Spectrum Techniques and Applications*, 2008 IEEE 10th International Symposium on (pp. 32-36).

## MOBILITY IN IP NETWORKS USING LISP AND OPENWRT

Cătălina Maria MĂLĂCEA, Dan Nicolae ROBU, Marian ALEXANDRU

Transilvania University of Brasov, Romania  
(catalina.malacea@yahoo.com, dan.robu@unitbv.ro, marian.alexandru@unitbv.ro)

DOI: 10.19062/1842-9238.2018.16.3.10

**Abstract:** *Because the Internet was originally designed to interconnect several hundreds of networks and now has more than one billion hosts, scalability issues have started to appear. The current scalability of today's Internet architecture is mainly due to the use of a single IP address space, both for identifying host transport sessions, and for routing networks. Due to the large amount of information on the Internet, routing protocols have an important role. The size of the routing tables in the Default Free Zone (DFZ) is steadily increasing. The underlying reasons for this rapid growth are the independent addresses of suppliers and multihoming. In order to help solve these scalability problems associated with the said increase, the LISP (Locator Identifier Separation Protocol) was developed. It allows the separation of IP addresses into two different address spaces: the identity of the device, known as Endpoint Identifier (EID), and its location, known as the Routing Locator (RLOC), as opposed to the current routing architecture and IP addressing, which use a single addressing space, the IP address. The approach described in this paper demonstrates two advantages of the LISP Protocol: 1. It allows changing the connection of an ongoing call using the Circuit by Unify application, from a wireless network to a 3G network without losing the connection, based on the use of the open-source LISP implementation Open Overlay Router (OOR) as a platform and 2. A user can be addressed using the assigned IP address, irrespective of the network connection used.*

**Keywords:** LISP, RLOC, EID, multihoming, OOR

### 1. INTRODUCTION

The Locator/Identifier Separation Protocol (LISP) started as a research in the Routing Research Group, making its way to the Internet Engineering Task Force (IETF), and becoming a very attractive technology for Future Internet Architecture. LISP can be used to accommodate the need for Internet growth while facilitating the deployment of new services.

LISP was proposed for the first time by Cisco in the IRTF (Internet Research Task Force) and now is under development in the IETF. This protocol has been developed from its original design to adapt to the Internet constraints imposed by it, but at the same time offering solutions for the scalability issues.

### 2. LISP OVERVIEW

LISP is a network architecture and a set of protocols that implement a new semantic IP addressing. LISP creates two namespaces and uses two IP addresses: Endpoint identifiers (EIDs) that are assigned to end users and routing locators (RLOCs) that are assigned to devices (mainly routers) that make up the global routing system.

The Locator / ID Separation concept has been considered important for solving the scalability issues of the DFZ routing table. By dividing the identity of the device, its endpoint identifier (EID), and location of the device (RLOC) into two different namespaces, improving scalability of the routing system can be achieved by a greater aggregation of RLOCs.

In the figure below, the LISP architecture is presented. It includes the Endpoint Identifier (EID), which defines “who” the device is and the RLOC, which describes how a device is attached to the network. The Egress Tunnel Router (ETR) receives packages from the Internet, decapsulates them and sends them to the EID. The Ingress Tunnel Router (ITR) receives packages from hosts, encapsulates them and sends them to LISP sites or non-LISP sites.

An Alternative Logical Topology (ALT) can be built for managing EID-to-RLOC mappings for LISP and for accepting the prefixes provided by devices and informing an aggregated EID prefix which represents that distinct space to other parts of the ALT. The Map Resolver (MR) connects to the ALT and accepts the messages from the ITR encapsulated in Map-Request, decapsulates them and forwards them to the ETR responsible of the requested EID message.

The Map Server (MS) manages the mapping database by registering the ETRs from the LISP Site with the EID prefix and publishes them in a database. The Proxy ITR attracts non-LISP traffic designated to LISP sites by allowing non-LISP clients to connect to the LISP site and encapsulating this traffic to LISP sites. Proxy ETR is used for non-LISP sites that want to receive traffic from a LISP site but the LISP site is connected to a service provider network that does not accept non-routable EID packages.

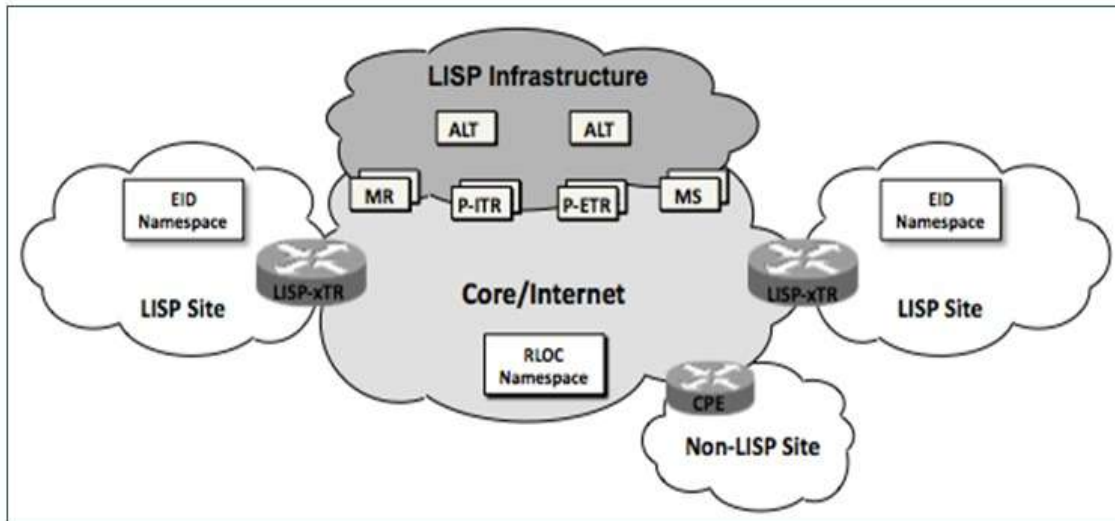

FIG.1 LISP architecture

**2.1 Multihoming.** Multihoming is a way to configure a PC that can have multiple network interfaces and multiple IP addresses. The multihomed PC is the host, which can be connected directly or indirectly to multiple networks, with the goal of increasing the network reliability.

The classic part is represented by a fixed network, being accessed via Wi-Fi, and the improvement brought is the multihoming mechanism with the 3G mobile network.

The multihoming is not new, but with LISP we get to keep our EID, so there is no change from the point of view of our partner.

### 3. PRACTICAL APPROACH

This section explains the structure of the network and the way in which the connection of an ongoing call can be changed using the Circuit by Unify application, from a wireless network to a 3G network without losing the connection.

The virtual machine OpenWrt - LEDE 17.01.1 x86 was installed in Oracle Virtual Box (which is a highly extensible GNU/Linux distribution for wireless routers [5]).

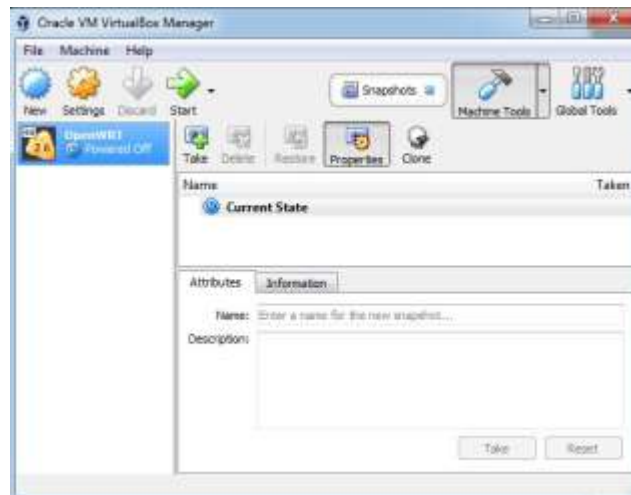

FIG.2 Installation of OpenWRT in Virtual Box

**3.1 Network Settings for Virtual Box.** The interface LAN 192.168.61.1, a host-only adapter on which the DHCP server was disabled in Virtual Box in order to retrieve the DHCP function from OpenWRT .



FIG.3 Host-Only Network Adapter

The Internet access was made through the NAT gateway, in order to download from the Internet the necessary packets for installing the Open Overlay Router (OOR). Network Address Translation (NAT) is the easiest way to access an external network from a virtual machine.

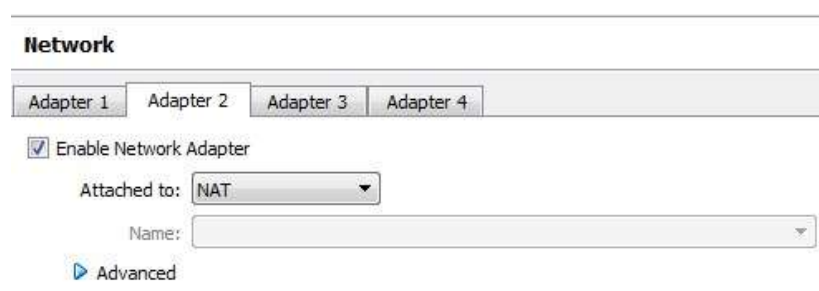

FIG.4 NAT Network Adapter

Further, the NAT network adapter was configured in Bridged mode, in order to access the Internet directly. With the help of Bridged network, Virtual Box uses a driver device on the host system, which filters data from the physical network adapter.

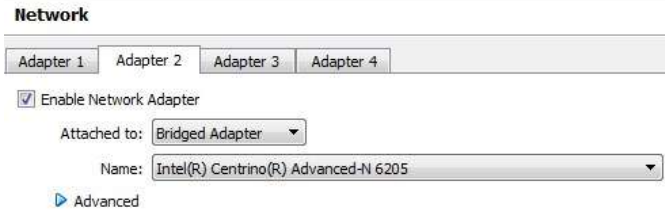

FIG.5 Bridged Network Adapter

**3.2 Open Overlay Router (OOR).** To configure the LISP protocol, an open-source modular solution was chosen: OpenOverlayRouter.

Open Overlay Router is an open-source application that can be used to create programmable overlaid networks. OOR is a complete implementation of the overlaid router, written in programming language C, available for OpenWRT, Android and Linux and being an open source under the Apache 2.0 license [7]. The OOR project is used to encapsulate packets in LISP-compliant packages and directs them over the basic physical infrastructure. In the current version, OOR uses the LISP control plan protocol (e.g., recovery and update mapping, etc.). Most of the OOR architecture revolves around the LISP protocol and its components. EIDs and RLOCs are impossible to identify from IPv4 and IPv6 addresses, allowing compatibility with the existing Internet architecture. A distributed database is responsible for maintaining associations between IDE and RLOC. Regarding the LISP devices implemented by OOR, it can now act as an xTR, MS / MR, RTR, or LISP-MN.

**3.3 Installing the OOR mobile application.** Open Overlay Router includes support for Android devices which work in a similar way to LISP-MN.



FIG.6 Open Overlay Router mobile application



**3.4 Installing OOR on OpenWRT.** The last version of the Open Overlay Router source code can be accessed at Github: [//github.com/OpenOverlayRouter/oor.git](https://github.com/OpenOverlayRouter/oor.git). In order to build the code for Linux operating systems, the command *make* was executed in the top-level directory. For installing in `/usr/local/sbin`, the command *sudo make install* was executed. Once the code was installed successfully on the device, `oor.conf.example` was copied in `/etc/oor.conf` and edited with the corresponding values.

**3.5 LISP Beta Network.** The experimental LISP network used for tests is the LISP Beta network, which allows us to test the scenario in real terms. LISP is being deployed at a Beta-Network; this pilot network is a multi-company multi-vendor effort to research real-world behavior of the LISP Protocol which includes approx. 156 LISP-enabled networks spread in 26 different countries. The Beta Network contains elements such as Map-Servers, Map-Resolvers, Proxy Routers and xTR's. Participants host one or more of these components [6].

**3.6 Configuration.** The configuration of the entire network is divided as follows:

LISP vlab.unitbv.ro is configured with a static IP to serve 2 LISP sites: LISP Site1 and LISP Site2.

Vlab.unitbv.ro is configured with a static university IP. Having a fixed IP, it constitutes an „anchor”, more precisely the RTR function. It takes over the traffic from the customers, from NAT networks and retransmits it to the LISP Beta network. Clients behind a NAT cannot be located by Map Server/Map Resolver and then the RTR becomes a „proxy” for them. A re-encapsulating tunnel router (RTR) provides communications support for LISP-to-LISP traffic between LISP sites that do not share common locator space. The functionality is that an RTR takes in LISP encapsulated packets from an ITR in one locator scope, decapsulates them, does a map-cache lookup, and then re-encapsulates them to an ETR in another locator scope. [8]

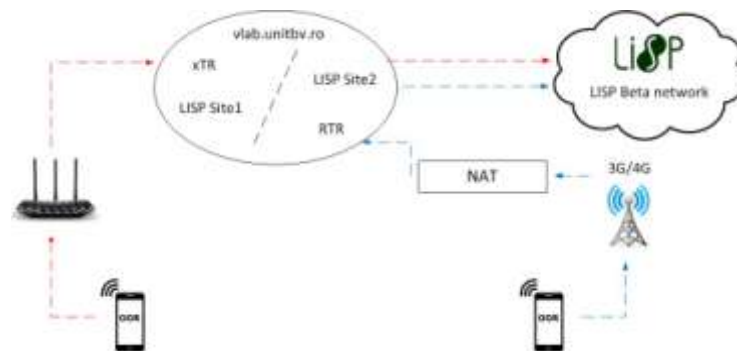

FIG.7 Network structure

In LISP Site1, the xTR is configured, providing both ITR and ETR functions and in LISP Site2 the RTR is configured, which is being required for the NAT Traversal function, as most 3G / 4G mobile operators use NAT. NAT changes a private IP address into a public IP address, in order to allow stations that use private addresses to access the Internet via a public one and hiding an unlimited number of devices under the same IP.

When NAT traversal feature is enabled, OOR is configured to send all data traffic through RTRs, even if the interface has a public address.

There are two possibilities when it comes to accessing the LISP Beta Network: access can be achieved through a Wireless Access Point, working as a bridge between vlab.unitbv.ro and the wireless network, which has direct connectivity to the network; or, through the 3G / 4G mobile network that has the application installed OOR, where the mobile is behind a NAT, being connected to an RTR that decapsulates the traffic received to re-encapsulate it again in the LISP Beta Network then on the Internet.

#### 4. TESTING THE SCENARIO

For the test scenario, the Circuit application, connected to the Circuit Server, was started; after that, an audio call was made. Initially, the audio call was made on a wireless network, after which the mobile network (3G) was activated and the wireless network was disconnected, so that the call was automatically transferred without interruption.

When the xTR (in fact ITR) receives a LISP packet, it asks the MS for the RLOC of the destination, if not already available in the local table (on Wi-Fi). When it changes to 3G, the RTR receives the packets and sends them. Both xTR and RTR addresses are known as a destination for the MN so the packets will reach the MN.

#### CONCLUSIONS AND FUTURE WORK

Mobility is related to a situation where a device changes its attachment to the network, which can be produced due to a physical movement of the device. The problem of changing addresses due to mobility happens when a host moves to a different network, because in this case it can no longer be reached by other hosts on the previous address and its existing data flows are terminated. In the above-presented scenario we were able to demonstrate an easy way to use a separate IP. Even if the temporal connectivity is interrupted, the device uses the same IP, therefore when the LISP connectivity became available again, the session continued exactly from the same place where it was interrupted. An advantage can be the keeping of the same identity, as authentication should not be reinitialized every time, since identity never actually changes. Separation between location and identifier is considered and recognized as the optimal method for user/host mobility.

As a future work, we intend to improve the security level of this project and to show how LISP can be used for IPv6 transitions, network virtualization, and mobility.

#### REFERENCES

- [1] \*\*\* ANR INFRA 2013 Project LISP-Lab, online resource accessed in April 24, 2018, at the address <http://lisplab.openlisp.org/>
- [2] D. Saucez, L. Iannone, O. Bonaventure, D. Farinacci – *Designing a Deployable Future Internet: the Locator/Identifier Separation Protocol (LISP) case*, vol. 16, Issue: 6, Nov.-Dec. 2012, pages 14-21;
- [3] T. Balan, D. Robu, and F. Sandu - *Multihoming for Mobile Internet of Multimedia Things*, vol. 2017, Article ID 6965028, 16 pages;
- [4] A. R. Natal, L. Jakab, M. Portolés, V. Ermagan, P. Natarajan, F. Maino, D. Meyer, A. Cabellos Aparicio - *LISP-MN: mobile networking through LISP*, *Wireless Personal Communications*, vol. 70, no. 1, pp. 253-266, 2013.
- [5] \*\*\* OpenWRT Project, online resources accessed in April 9, 2018, at the address <https://openwrt.org/about>
- [6] \*\*\* LISP Beta Network, online resources accessed in May 3, 2018, at the address <https://www.lisp4.net/beta-network/>
- [7] \*\*\* Open Overlay Router (OOR), online resources accessed in April 18, 2018, at the address <http://www.openoverlayrouter.org>
- [8] \*\*\* Locator ID Separation Protocol (LISP) Overview, online resources accessed in April 20, 2018, at the address [https://www.cisco.com/c/en/us/td/docs/ios-xml/ios/iproute\\_lisp/configuration/15-mt/irl-15-mt-book/irl-lisp-support-for-disjoint-rloc-domains.html](https://www.cisco.com/c/en/us/td/docs/ios-xml/ios/iproute_lisp/configuration/15-mt/irl-15-mt-book/irl-lisp-support-for-disjoint-rloc-domains.html)

## GLOBALISATION OF THE ECONOMIC, SOCIAL AND POLITICAL REALITY OF INDUSTRIAL CULTURES

Daniela BELU

“Henri Coandă” Air Force Academy, Brasov, Romania (daniela.belu@afahc.ro)

DOI: 10.19062/1842-9238.2018.16.3.11

**Abstract:** *There is a question of whether the norms can have an objective reality, and not of whether the fulfilment of the needs enriches the life of the individual, suffocates him, prevents his or her development or is, on the contrary, self-destructive. The actual and conceptual liberation of reasoning are distorted by the person's tendency to restrain to the wonders of technology, which are the result of the new science, thus excluding the human being who is gets reduced to the role of a tool used for economic purposes.*

**Keywords:** *economy/ harmful products for the consumer/ self-analysis/ real self*

### 1. GENERAL ASPECTS

The objective to change the economic, social and political realities of the modern industrial society has been concentrating for more than a century on the manner in which the modern man organizes his work within his own life. Production management (the technology of producing goods/services) must be put into practice, without disturbing the existence of the individual, the manner in which the individual is happy/the manner of being happy and the way in which he searches for his own spiritual wellbeing, by becoming aware and by self-analysing what is his real state of „wellbeing”.

The realities that have been rooted in the structure of the industrial culture for more than a century are based on „having” and on increasing the subjective strengths, by amplifying the individual's narcissism due to his incapacity to reason and love (Erich Fromm, [1]). The abilities to reason and love are characteristic of the orientation towards “being”. Ever since the occurrence of the industrial organisations, “having” and “being” have become alternatives that are understood in the context of the industrial culture as the two potential fundamental modes of existing, respectively as two different types of character structures, whose predominance determines the totality of the ways in which a person thinks, feels and acts (Erich Fromm, “A avea sau a fi (*Having or Being*)”, 2013, p. 40).

The individual who builds his lives in the “having” mode establishes his existence by choosing his purpose in life according to what he has, could have or could have more of. For the individual who chooses to have, things become objects of possession of various types: houses, money, stock, art, books, stamps, scientific titles, social status and relationships with influential people etc. that the individual shall collect with the limitless passion of a collector, for the sake of possessing them, without any relation to his personal needs of consumption or use. For the supporters of “having”, peers become objects of possession, in the sense that, by assuming responsibility for them, the individual is also entitled to dispose of them (children, people with disabilities, elderly people, sick people etc.), thus taking them into his possession and considering them part of his own self.

This becomes obvious once the person that requires care wishes, at a certain moment, to make his/her own decisions in what concerns his/her own person. For the individual who lives in the “having” mode, the objects of possession become all that matters in order to make him esteemed/admired, such as virtues, honours, a certain image, health, beauty, youth and with old age, experience, memories, ideological/political/religious convictions that are fiercely protected as possessions. The “not having” orientation (asceticism) is in fact also an orientation towards “having”. At the same time, the orientation towards “being” is not the same as the orientation based on “not having” (E.Fromm, 2014). It is difficult to distinguish whether you possess anything without analysing what is valuable for yourself and without having any idea of what would happen if you were to lose what is useful/important to you and you cannot feel that you are independent or valuable, intrinsically, if your life and work no longer involve having a vocation, well-behaved children, a good relationship, profound intuitions, better arguments etc. The individual who is oriented on what he has or on what he lacks shall always use an external object to exist, since for him, being means to possess something and becoming a subject means possessing an object. He shall be constantly devoured by the objective of having in order to believe that he exists. This represents a mass phenomenon that is based on the economic and social realities of the globalised society, which is defined by the immense loss of the individual psychic strength that is found in the structural realities of the current economy, exacerbated in the context of the economic and political globalisation, of the current management and cultural life.

Any individual has the required mental abilities to be independent, such as the capacity to love, to reason, to conduct a productive activity. Unfortunately, the majority of individuals replace these innate mental strengths with the depersonalization that is caused by the abundance of the consumer society, in which the economic and social relationships condemn the individual by reducing him to the “having” stereotype. Love, reason and productive labour represent mental strengths or forces that are born and developed gradually, as they are shared with the others, to the extent that they cannot be purchased or owned as objects of possession, but only practised, exercised, risked and fulfilled. “Being” entails the creation of a better relationship with oneself and with one’s environment, i.e. man’s life purpose by orienting one’s own mental strengths towards learning/accepting the characteristics of one’s own self (E. Fromm, 2013, p. 175).

Man has always been a social being and the values that guide his social and economic style need to be changed in the sense of creating the proper conditions for the individual to express his mental strengths in an authentic manner, to exert his reasoning, love and productive activity, with a view to enhancing them by means of use. Man should become aware of and develop his own self, by getting the perspective of himself and of the world he lives in, according to his internal and external reality, to the extent the life praxis manages to free itself from contradictions and irrationality.

“Being” involves the passage from selfishness and egocentrism to solidarity and altruism, while becoming aware of the meaning of life for a human being and of what we expect from life. The joy of living is specific of all living creatures, but in man this biological impulse can be paralysed under exceptional circumstances such as some unbearable pain of mental nature that might arise from passions that become more powerful than the desire to live.

Human beings differ from each other based on what they expect from life, i.e. some crave for love, others want power, others desire the pleasure of the senses, but the majority of them desire happiness. For the average man, happiness means “having what one desires”. Basically, individuals differ from one another based on what they desire and this leads to the issue of the human needs.

There are two opposite positions with regard to this topic:

1. The tendency to objectify happiness by getting pleasure from fulfilling one's needs, which is generally accepted nowadays. The need is subjectively considered the fight for something that is desired sufficiently to be considered necessary and that provides pleasure if obtained. Needs can be of various types:

- physiological needs (hunger, thirst etc.)
- social/cultural needs (art, theoretical thinking, refined beverages)
- socially induced needs (smoking, vehicles, gadgets)
- pathological needs (sodomasochist behaviour).

Morality is not taken into consideration; therefore the fact that the fulfilment of the needs could be self-destructive is ignored. Listening to Chopin or satisfying one's sadism by slandering innocent people are considered a matter of taste, as long as it is what an individual desires, happiness being represented by the fulfilment of that particular desire. The only exceptions are the situations that are provided in the minimal ethical standard, i.e. the law, respectively those cases in which the fulfilment of one's need severely affects other people or the social usefulness of the individual himself, for example the use of drugs, driving under the influence of alcohol, etc.

2. The tendency to objectify happiness by fulfilling certain needs that are deeply rooted in the human nature only if it guarantees the individual's self-fulfilment, by complying with the following norms with objective validity:

- defeating greed/illusions/hatred
- getting love/compassion/gratitude.

To fully become what you are in a potential manner, allowing judgement to guide your understanding of the norms that lead us to a state of wellbeing, to the extent that our reasoning allows us to understand the human nature (Toma din Aquino). The pathological and obviously harmful character of irrational passions such as the desire for fame/power/ownership, the desire for revenge, the desire to control the lives of others has been proven to be harmful from a theoretical and clinical point of view. For example, the typical disease for managers is the peptic ulcer, which is caused by an unhealthy lifestyle and the stress caused by exacerbated ambition, the addiction to success and the lack of an honest personal core. Wrong attitudes represent the cause of somatic diseases. This fact has been proven in the last decades by the results of the scientific research conducted in the field of neurology. C. Von Monakow, R.B.Livingston, Heinz von Forester have suggested that the human being has been equipped with neurologically integrated biological consciousness, in which certain norms are rooted such cooperation and solidarity, the search for truth and freedom (E. Fromm, [5]).

The liberation from greed, from the handcuffs of illusions as a life purpose can be found in the religious systems (the Indian Vedas, Buddhism, Chinese and Japanese Zen Buddhism, Judaism and Christianity), in the absolute development of Christian and Muslim mysticism, in the Near East and the Western World. However, internal liberation is inseparably linked to the development of reason, which is understood as the use of thinking with the aim of knowing the world as it is and in opposition to "the manipulation of intelligence" and in opposition with the use of reason with the aim of satisfying certain needs. The supremacy of reason starts with the liberation from greed, because man's judgement operates only up to the point in which it is overcome by greed. The loss of objectivity makes the individual a prisoner of his own passions and determines him to rationalise when he believes that he expresses the truth. Within the industrial society, the concept of liberation as a life purpose has been distorted through limitation to the outer man, emphasis being laid exclusively on the political strengths and frequently crippling the inner individual.

Oftentimes, the liberators have turned into new masters and the ideologists of freedom have often hidden new, better dissimulated and more anonymous forms of lack of freedom underneath the concept of political liberation (E. Fromm, [1]). Man can be a slave without being put in chains and, in some rare cases that are not at all significant for the current times, man can be free even while in chains. Nowadays, the fact that the chains have been simply placed inside of the individual's consciousness is crucial. By deluding himself that he is free, modern man is suggestible to stronger desires and thoughts than some real chains, thus being unwilling to liberate himself from a slavery that he is unaware of.

At the end of the 20<sup>th</sup> century, E. Fromm believed that the industrial society could exceed the crisis in which it still finds itself only by means of a "total liberation", while the church speaks of an inner liberation and the political parties speak of an external liberation with the help of reason, under its two aspects, i.e. *science* – the study of nature and *self-awareness* – the study of the human being. Liberation has been distorted by way limitation, just as the concept of reason, which has tried to include nature by creating wonders of technique as fruits of science, while excluding man as an object of study, with the exception of the alienated forms of psychology, i.e. anthropology and sociology. In the limited framework of the bourgeois materialism, man has progressively degraded and become a simple tool used for economic purposes.

## 2. OBSTACLES IN THE WAY OF "BEING"

Man, in his attempt to live in the "being" mode, has to face **imposture**, an obstacle that is not at all negligible and widely spread in all the spheres of the society and that is manifested in the economic phenomena that are non-sanctionable by law, such as:

- Products with planned aging, such as old wine;
- Products that are excessively expensive or useless, such as cars, jewellery, company assets;
- Harmful consumer products, such as medicine, food, toys;
- Advertising as a mixture of a little bit of truth and a lot of lies.

The cause of this imposture in the economy, which is illustrated by the above mentioned phenomena, represents the managers' conception that is led by the interest for maximum profit and not by the maximum utility of the products. In the world of artistic and literary phenomena, the uncontrollable cause of imposture is actually represented by the public that it addresses and that has become incapable of making the difference between what is authentic and what is fake, either due to their purely cerebral orientation manifested through the fact people read/listen to words and intellectual concepts, but are unable to feel the authenticity of the reality of life transposed in an artistic manner into literary production, or because of the hypnotic attraction exerted by power and fame, which are induced by advertisements that cleverly manipulate the readers, making them believe the information provided in the advertisement. The inner value of the art producer matters as little as that of a bottle of beer and the fact that the artist is good, productive, courageous or intelligent does not matter too much if said qualities haven't served him/her to become successful (op. cit. page 33); even though mediocre, narcissistic, aggressive, a drunkard or obscene, if always on the first page of newspapers, the artist shall become "a top rated one". Art critics, literary agents, PR staff, editors, all play a certain role in building the artist's image and, alongside the artist, they are all impostors.

Imposture is manifested even in the field of redemption, of gaining the inner freedom, of internal growth and happiness, and it manifests as follows:

- Priests that no longer have the right to serve, but continue to do so (by ignoring the authority of BOR – the Orthodox Church of Romania – that has forbidden them to serve) within limited liability companies that can be contacted via the internet;

- Sects (the human spirals of Gregorian Bivolaru, the Metropolitan Church of Moldo-Walachia consisting of priests that have been cast out by the Orthodox Metropolitan Church of Romania, the ELTA association led by Ion Dumitrescu, the Mormons, the followers of transcendental meditation etc.) that recommend themselves as producers of spirituality and that adopt the characteristics of great businesses: advertising, internet, vague and sometimes incomprehensible language referring to certain ideas, the cult of a smiling leader. Under these conditions, the existence of a spiritual movement and the success thereof becomes predictable, the same as with patented medicines. Spread untruths can lead to a catastrophe because they make naïve people blind to danger and real possibilities.

Trust in life, trust in one's self, self-knowledge of one's own qualities must be built on realism, as a capacity to see evil where it actually exists, to recognise treachery, destructiveness and selfishness, not only when they are obvious, but also in their various disguises and rationalizations (op.cit. page 42).

### **3. THE TRIVIALITY OF COMMUNICATION IN THE “HAVING” MODE**

Modern man is alienating himself from his peers, which condemns him to face two types of anxiety: on the one hand, the fear of being lonely and, on the other hand, the fear of relating to other people. His main issue is how to remain alone without being a loner. In these conditions, modern man asserts himself by communicating, believing that he exists only to the extent to which he talks about the fact that he is somebody, that he has a past, that he has a job, that he has a family. Nevertheless, he needs the pretext of dialogue and an audience that creates the illusion of interaction, when, in fact, he is having a monologue. The triviality comes from the lack of liveliness, the lack of receptivity and from the fact that he cannot feel entirely alive. The triviality of communication in the “having” mode is represented not only by vulgarity, triviality, dullness, destructiveness, the hostility towards life, sadism and malice, but also by the attitude that fails to make a distinction between the essential and non-essential of the topic of the communication or the tendency to invert the two aspects.

Interhuman interactions significantly affect all the participants and the impact, not at all negligible, can materialise either when the content of the conversation is responsible for such change, in situations such as: feeling touched by the interlocutor's kindness, being appalled by the image of a diabolical expression, getting the good spirits, being full of energy, improving one's mood, becoming more courageous, finding an inner inspiration, or when, on the contrary, the content of the conversation is not responsible for said change, in case of depression, fatigue, hopelessness. In general, unsuitable company cannot be avoided and, therefore, what is left for us to do is to see the dishonesty behind the mask of friendship and the narcissism behind the charm of the interlocutor and for us to remain authentic, without dissimulating that we have been misled by the deceitful image of the other. We shouldn't talk about we see/we believe with people that do not understand our behaviour and we shouldn't try to convince them that we are blind.

We do not owe explanations to anyone and we do not have to account for our actions as long as those actions do not harm or do not violate the other person's rights. A free man owes explanations only to himself, to his own reason and consciousness and to the few people that could have a justified reason to request an explanation (op. cit. page 48).

#### **4. THE “NO EFFORT AND NO PAIN” DOCTRINE IN THE “HAVING” MODE**

One could feel inclined to believe that the people within the modern society need wars, wrongdoing, scandals and even illnesses, only to have something to talk about, i.e. to have a reason for communication even at the level of banality. This doctrine of the little effort is popular in all fields of activity. For example, in education, in the name of “self-expression”, “anti-elitism” and “freedom”, courses are conceived to be as easy to grasp and as pleasant as possible. The teacher who insists upon sustained activity is called “authoritarian” or old-school. Nowadays, the social system promotes the false belief that one is not obligated to do what one does, but what one likes. The replacement of direct authority by an anonymous authority (op. cit. page 50) finds its expression in all the fields of life; strength is camouflaged by consent; consent is obtained through methods of mass suggestion (op. cit. page 50). As a result, study too must be felt as being pleasant, not mandatory but optional, and not in fields where the need for important knowledge is maximum, such as the natural sciences, where “easy lessons” are not possible.

On the other hand, the same system has diminished the amount of physical energy required for the production of goods. During the first industrial revolution, the animal/human physical energy was replaced by the mechanical energy of the machines. During the second industrial revolution, reasoning and memorising were replaced by computers. The liberation from said labour is considered modern “progress”, to the extent that the energy released in this manner is applied to other tasks that are more creative. Obviously, things did not go as planned. Automation/cybernation has led to the ideal of “absolute laziness”, of the horror of any real effort. A good life is a life that lacks effort and the supporters of the “having” mode make great efforts only when forced to do so and never willingly (they take the car to the shop in the corner in order to avoid the effort of walking only because it’s raining, or they use the calculator to avoid the mental effort of addition). The “no effort” doctrine is directly linked to the “no pain” doctrine, which consists of avoiding pain, especially mental pain. The “having” mode people develop a chronic phobia to pain in its broadest sense, including both physical and mental pain. It is painful to excel in any field (to do arpeggios, to rehearse a theatrical play, to train for the Olympics in mathematics/athletics/ gymnastics, to learn for an exam session) when you only feel like having fun with your friends. These are minor pains that the “being” people have learnt to accept happily (due to the motivation of self-achievement), without any problem, because they have wished to learn the essentials and to correct what is wrong in their personal hierarchy, by accepting the reality that happiness is only a flicker of the revelation that one is/exists on the path that one has chosen, that suits him/her and that is worth making sacrifices for, but which entails suffering. Sharing the individual suffering with the suffering of peers represents the basis for human solidarity in the “being” mode (op. cit. page 51).

#### **5. CONCLUSION: THE ANALYSIS OF THE METHODS OF PASSING FROM THE “HAVING” CULTURE TO THE “BEING” MODE OF LIVING**

The majority of the attempts to make changes in organisations are doomed to fail, because they do not address culture-related problems, i.e. they do not refer to the implicit presumptions in the behaviour of people as human resources. All the organisations – schools, hospitals, companies, military units etc. – involve certain behaviour and certain results. A certain behaviour, such as wasting time, creates certain results, such as the acceptance of the situation blindly.



Very soon, we shall accept, in a conscientious manner, that a certain behaviour leads to certain results, and this cycle, behaviour-results-expectations persists in time in the unconscious attitudes, and we become more aware of our expectations rather than of our attitudes. This cycle has two loops:

- Behaviour-results-expectations
- Behaviour- results-attitude.

When the behaviour and the results are maintained for a long time, in general for many years, the culture shall form and we are no longer aware of culture.

The management pursues results and, in order to obtain results, an appropriate behaviour is required. If attempts are made to change the behaviour of the people in an organisation, then attempts should also be made to change the people's expectations (for example, they should be aware of the fact that an increase in productivity is required for survival; this is why the increase of gains must be assigned to self-financing and not to the increase of wages from one year to the next) and the attitude and culture of human resources shall compensate for said changes in the behaviour, results and expectations. Progress should be made in the education of the people to make them see the arguments and to reflect on them.

Human resources exist in a state of dynamic balance between the closed system and open system. An opportunity from the individual's exterior environment shall have more chances of becoming reality if it is associated with a strong point inside the individual (for example, the opportunity to form a mixed company corresponds to a strength of the entrepreneur, such as the high operational flexibility and not a weakness, such as the restrictive practices). Based on the same logic, a threat coming from the external environment, coupled with a person's weakness, can become damaging, harmful (for example losing clients due to improper quality, coupled with a weakness, such as a person's inability to face change, could lead to dismissal). On the contrary, a threat that is associated with a strength can diminish the individual's losses (for example losing clients due to improper quality, coupled with the ability to face change by means of learning shall rebalance the individual's professional life).

What needs to be done is to minimise the threats and to maximise the opportunities by means of constant adaptation, which makes it possible for the strengths to be triggered. Weaknesses shall always exist and this is the reason why efforts are constantly made to overcome them. As long as the strengths/weaknesses correspond to the chances/dangers existing in the individual's external environment, the chances for the individual to succeed in life are even higher. The mismatch areas correspond to the individual's needs for development by means of adaptation.

The "being" mode kind of individual can be described from the perspective of 4 aspects:

1. The inner force

- What is the individual's mission, what does he like to do, how does he become aware of the meaning of life?

- What is the defining skill of the individual in work/life?

- What kind of potential does the individual become aware of/value in relation to his peers/the society?

- What advantages does the individual gain from work/communication/ public recognition/life situations?

- What does the individual's strength consist of? Is it the specialised workers, the possession of relevant technical expertise, holding protected patents, advantageous commercial leases/rents, altruism etc.?

## 2. Weaknesses

- What is the individual bad at, what does he not like to do?
- Is the individual's potential useless/unexploited?
- Is the individual disadvantaged as compared to his peers?
- Is the individual obligated to carry out work/life in deteriorated buildings, with old equipment, to apply restrictive work practices, collaborating with unqualified workers, to apply obsolete technologies?

## 3. Opportunities

- What are the opportunities in that particular environment?
- Have new markets emerged?
- Is there a possibility of a boom in the demand for what the individual knows how to do?
- Could the macroeconomic factors improve the commerce/production of what the individual makes?
- Is it possible for the restructuring of subsidising agents (supporters/protectors/mentors) to precede more generous reassignment subsidies?
- Could the fluctuations of exchange rates and low interests provide competing advantages to the individual?

## 4. Threats

- What kind of threats could there be in the environment?
- Could the economy enter a period of recession?
- Could the international markets raise restrictive barriers?
- Is the industry/health/education/agriculture involved in a contracting process?
- Has the individual's potential for development diminished?
- Is the individual threatened by vandalism, terrorism, crime?

Regardless of our skills as strategic managers of the organisation or of our own lives, in the end, we shall become aware of the degree of optimisation of the exit/entry ratio that we provide, based on the added value and on the social values that intervene, through the manner in which we make our work more productive by means of execution or management, under both of its aspects:

- the proper application of the method, i.e. efficacy;
- time consumption, i.e. efficiency;

By, taking ourselves and not others as examples, by creating better relationships with ourselves and with our environment, we understand the purpose of our own lives by focusing our mental strength on learning/accepting the characteristics of our own self.

## REFERENCES

- [1] E. Fromm, *Arta de a fi*, Trei Publishing House, 2013, Bucharest;
- [2] E. Fromm, *Greatness and Limitations of Freud's Thought*, New York, Harper&Row, 1980;
- [3] E. Fromm, *Medical Nemesis: The Expropriation of Health* New York: Pantheon, 1976 ;
- [4] S. Freud, *Opere esențiale*, vol. 7, Trei Publishing House, 2000, București;
- [5] E. Fromm, *The Anatomy of Human Destructiveness*, New York: Holt, Rinehart and Winston, 1973;
- [6] E. Fromm, *Frica de libertate*, Teora Publishing House, 1998, Bucharest;
- [7] E. Schein, *Organizational Culture and Leadership*, San Francisco, Jossey-Bass, 1985;
- [8] J. Lichtenberg, *Psychoanalysis and Motivation*, Hillsdale, NJ, Analytic Press, 1989;
- [9] D. Goleman, *Emotional Intelligence*, London, Bloomsbury, 1995. Harper&Row, 1989;
- [10] Beaud, M., *Istoria capitalismului*, Cartier Publishing House, Bucharest Cameron, R.A. (1993). *Concise Economic History of the World from Paleolithic Times to the Present*, Oxford, New York Gallagher, D.R. (2001).

## AMERICAN ART EDUCATION IN THE LIGHT OF GLOCALIST APPROACH

Review of the volume *Current Streams in American Art Education* by Elena Polyudova, Cambridge, Cambridge Scholars Publishing, 2018

Adrian LESENCIUC

“Henri Coandă” Air Force Academy, Braşov, Romania (a.lesenciuc@yahoo.fr)

DOI: 10.19062/1842-9238.2018.16.3.12

**Abstract:** *Current Streams in American Art Education*, written by the American researcher of Russian origin Elena Polyudova, is a prevalent work on the topic. The author analysed the realities of the American curriculum design in the light of current concepts, using the key for deciphering current social challenges. With a formative background in the pedagogy of liberal arts in Moscow, Elena Polyudova manages to offer a valuable book, enriched by the light of comparative analysis and of the glocalist approach.

**Keywords:** art education; aesthetic experience; glocalist approach.

### 1. ELENA POLYUDOVA: SCIENTIFIC PROFILE

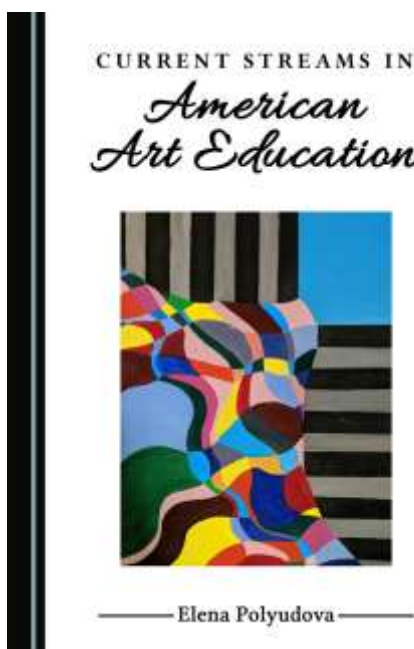

FIG.1 Elena Polyudova, *Current Streams in American Art Education*. Front cover.

Elena Polyudova is a complex scientific researcher, having graduate studies in the field of arts in Moscow. She glides along research topics ranging from of philology to education sciences. She is an independent scholar, who manages to reasonably cover all her areas of interest in research because of her extraordinary capacity to synthesize.

She innovates therefore by bringing into her research theories, models, instrumentalities and methods belonging to related knowledge areas. Currently a Distant Associate Scholar at the Institute of Art Education and Culturology at the Russian Academy of Education, Russian and English language instructor at Berlitz Language Center in Palo Alto, California and in other several institutions in Silicon Valley, California, member of editorial committees in Italy and Russia, Elena Polyudova has been an independent researcher and distant research fellow at the Russian Institute for Art Education Studies in Moscow, the Head of the Research Group at the Moscow State Palace of Child and Youth Creativity in Moscow and the founder and head of the School for Teachers' Education in the same city. Her education, also complex, encompasses her initial training as a philologist and aesthetician through bachelor and master studies (with an interest in researching the Russian futurism in Vladimir Mayakovsky's literature and in Elena Guro's paintings), then as specialist in teaching Russian as a foreign language – all of these at the Lomonosow Moscow State University –, and as a specialist in art education through doctoral studies at the Russian Academy of Education, Institute for Art Education Studies, Moscow, Russia. She founded and led several research centres in art education. She published and edited important articles and books in Art Education, such as: *Current Issues and Strategies in ES Studies* (2014), *Once upon a Time in the Contemporary World: Modern Vision of Old Stories* (2016) and *Soviet War Songs in the Context of Russian Culture* (2016).

*Current Streams in American Art Education* is Elena Polyudova's latest work, the result of an external analysis on the American educational system, focusing on Art Education and on currents related to this educational dimension. The book also includes the comparative analysis of the Russian and American educational systems regarding Art Education. The investigative approach is organized on chronological coordinates. The author structured the book in a deductive and historiographical projection on four chapters, dealing with the forefront aspects in the development of artistic education in the United States of America: I. *Art Education in the USA*; II. *XX century: Classic Era. The Concept of the Aesthetic Experience in American Art Education*; III. *XXI century: Wind of Changes* and IV. *Current Streams in Modern American Art Education*. Therefore, Elena Polyudova proposes a prevalent and interesting work, analyzing Art Education in the USA from a historical and comparative perspective, organizing the contents around a transcultural and transdisciplinary concept: the aesthetic experience.

## **2. ART EDUCATION IN THE USA**

Elena Polyudova's work first proposes a framework for defining concepts tightly related to the two cultural spaces: Russian and American. Art Education in the United States means „the basic form to describe the process of teaching visual art” (Polydova, 2018:6), and in Russia it has a broader range of meanings, referring to visual arts, music, dramaturgy, art craft and so on. The equivalent term for the Russian meaning is “aesthetic education”. Interestingly, in Romanian pedagogy the phrase “plastic arts education” stands for “art education” in the USA, and “aesthetic education” (see, for example, the *School Programme for Plastic Education*, 2017) stands for the Russian meaning. Differently, in the Republic of Moldova, the term “art education” is applied to the same content as in the Russian school, although it is subordinated to the concept of “aesthetic education”: “Art education (...) is done by getting to know/understand beauty, through different arts: literature, music, drawing, painting, dramaturgy, choreography, etc.” (Morari, 2016:63).

For an adequate placement in art education analysis in the USA, Elena Polyudova proposes a succinct presentation of the American education system – with comparative references to European and Russian education – highlighting the additional role of arts education in the American curriculum:

Traditionally, the most important subjects are math and science- related ones, but the humanities and art-related subjects are considered as additional, even supplemental, to the core disciplines (Polyudova, 2018:12).

However, the child's encounter with art education occurs early – even if American pre-school education is not considered as important as in Romania, for example („many preschool institutions provide only day care services”, Polyudova, 2018:15) – and supposes in elementary and middle education the allocation of 1.5 to 4.5 hours per week, depending on the specialization and the tradition of aesthetic education proposed by V. Lowenfeld. Therefore, for a thorough approach, the author designs both the framework for defining and applying art education, and the pedagogical fundamentals of the subject. Art education starts formally since the introduction of Technical Drawing in the curriculum, as a proposal of Boston Committee for the Congress in 1870, and informally with J. Dewey's pedagogical school. The American psycho-pedagogy fundamentals are the pragmatist pedagogy of W. James and G.S. Hall, the methodology of G. Brunner, the polycultural education of W. Bronfenbrenner, J. Verch and J. Reed, the behaviorism of B. Skinner and the humanistic psychology of A. Maslow and C. Rodgers, all based on the pedagogical projection of J. Dewey. The parallel between the most important representative of the Chicago School, John Dewey, and the most important representative of the Russian school of pedagogy, Lev Vygotsky, is very interesting both in terms of setting the foundations of education sciences and the organization of education systems in their countries, and regarding the convergence of their approaches:

After J. Dewey experience as a core concept of education because an essential part of any educational movement in American art education, turning scholastic and theoretical pedagogy into live experimental science that teaches through actions and experiments. These ideas simultaneously resonate in the works of another great scholar, Russian psychologist L. Vygotsky, who defines as the leading process, playing a crucial role in a child's development (Polyudova, 2018:8).

As she analyzes education in the United States, Elena Polyudova describes with refinement the deepening of the issues concerning: artistic perception, creative expression, historical and cultural context, aesthetic valuing, connections, relationships and applications, on different levels: beginner, intermediate, and advanced placement, based on Visual and Performing Arts Standards, commenting and exemplifying each particular projection.

### **3. STREAMS IN AMERICAN ART EDUCATION IN A LONGITUDINAL PERSPECTIVE**

In later chapters, dealing with aspects of Art Education in the USA, Elena Polyudova describes models of artistic experience based, in accordance to Dewey's perspective, on “aesthetics and aesthetic aspects of philosophy, psychology and didactics”, despite the fact that these concepts remain largely vague or inadequate.

Starting from this non-rigid projective reality, the author proposes a way of understanding both facets of aesthetic education, namely artistic competence and individual perception.

The models of aesthetic experience that exemplify the implementation of formative requirements in American Art Education are deepened and explained at the level of broad public understanding: Abigail Housen, with her Visual Thinking Strategies;

Michael Parsons, with the Stages of aesthetic development; Stanley E. Horner, who proposed „eight stages of reaching a balanced and complex response to an art object”; Colette Dufresne-Tasse, with her model of museum education and with the “three types of discourse with a work of art”; Boyd White, the author of an aesthetigram, highlighting the social and cultural human values expressed in art. But, Art Education dramatically changes as the term “aesthetic experience” is replaced by other concepts that become more and more relevant in relation to art objects, and for expressing the expansion of personal experience with real and virtual art objects in the visual era. The exemplification concerning the of preoccupation for the possibility to adapt the new requirements of artistic education based on the studies of Professor P. Duncum from the University of Illinois is enlightening for a proper understanding of the context. Again, just as important is the radiography of the specialized literature, including her own recent articles, reflecting current trends in American Art Education, even if in the visual era the role of Art Education did not change; it still remains marginal, additional, somewhat secondary.

Art Education has strong cultural roots. The American society is characterized by phrases such as “national polyphony” and “multicultural environment” (Polyudova, 2018:63). Consequently, the multicultural dimension of the American Art Education becomes one of the fundamental dimensions, that radically alter the perspective on curriculum development in the area. Elena Polyudova argues in her previous articles in favor of the use of “personal culture” as a concept meant for the American youth due to her education in a different cultural space and to the major influence of philosophers and specialists in pedagogy such as V.P. Zinchenko, V.S. Bibler, A.G. Asmolov, D.A. Leontyev and V.M. Rosin:

Generally speaking, the term „personal culture” is close to all-over-the-culture competency that may be improved through education, communication, and other personal and social activities. This term could be expanded via development of different directions of a person’s inner world. Accepting and implementing cultural codes and patterns, a persona carries them in his personal space. (Polyudova, 2018:69).

This perspective is very valuable. In a multicultural environment, Elena Polyudova uses her experience of understanding and applying the concept of “personal culture” to Russians, where it is translatable through cultural competence (meaning “education + erudition”), respectively for Americans, where it means social competence (social “skills + responsibilities”). Putting together the different angles under which the the American educational system is approached –from the perspective of Art Education – encompassing different challenges in a multicultural manner – means using the term “dialogue”, its maieutic virtues, but rather in M. Bakhtin’s personalized understanding of the term, i.e. a unitary structure of language (with all associate meanings formed in the Russian educational system, by reference to S. Rubinstein, L. Vygotsky and V. Bibler). Dialogue as an educational principle is the fundamental proposition of Elena Polyudova’s work.

#### **4. CONCLUSIONS**

Elena Polyudova’s book *Current Streams in American Art Education* is a very important work, that radiographs Art Education in the USA from an external and comparative perspective, by means of a longitudinal analysis that also touches the aspects of the current perspective on this subject: the heightened speed of visual perception, the high level of creativity and weak skills in evaluation. In addition, placing American Art Education under the sign of multiculturalism – „In recent Art Education studies (National Art Education Association 2012-2017) multiculturalism is intertwined with the concept of socialization” (Polyudova, 2018:93) – Elena Polyudova manages to propose a prevalent work.

The book should be read neither as a study having a pronounced national dimension (even if its title refers to a national curriculum), nor as a globalist approach (even if the Americans are the promoters of the current). The book should be read as a moderate and inclusive glocalist approach, where glocalisation should be understood as a phenomenon specific to school life.

### REFERENCES

- [1] Ministry of Education. (2017). *Programa școlară pentru disciplina Educație plastică. Clasele a V-a – a VIII-a*. Anexa nr. 2 la Ordinul ministrului educației naționale nr. 3393/ 28.02.2017. *Monitorul Oficial al României*. Nr.164bis/07.03.2017;
- [2] Morari, Marina. (2016). Respiritualizarea educației artistice. În Tatiana Bularga *et al.* (eds.), *Valorificarea strategiilor inovatoare de dezvoltare a învățământului artistic contemporan*. Bălți: Universitatea de Stat „Alec Russo”. 62-65;
- [3] Polyudova, Elena. (2018). *Current Streams in American Art Education*. Cambridge: Cambridge Scholars Publishing.