

AUTOMOTIVE SAFETY AND THE CRUISE CONTROL SYSTEM

Mădălina BORCAN, Cornel STANCA, Marian ALEXANDRU

Transilvania University of Brasov, Romania
mada09b@yahoo.com; cornel.stanca@unitbv.ro; marian.alexandru@unitbv.ro

DOI: 10.19062/1842-9238.2018.16.3.7

Abstract: *Dozens of electronic control systems are installed on modern vehicles, meant to optimize the parameters of the functional subsystems of the vehicle as a whole. This paper integrates two of these subsystems: the active safety subsystem – the distance control subsystem assessing the distance to the front vehicles – and the subsystem controlling cruising speed. The functional validation of the two integrated subsystems has been done on a demonstrator, a motorized model powered by a DC motor. The control algorithms were implemented in a PIC microcontroller.*

Keywords: *automotive, safety, cruise, design, control, system, PicKit3*

1. INTRODUCTION

The cruise system technology presented in FIG.1 is considered as a key component of any future generation of intelligent cars. This influences driver safety and comfort and increases road capacity, maintaining the optimal separation of the vehicle from the surrounding traffic and reducing driver errors, while also optimizing resource consumption [1].



FIG. 1. Radar Cruise Control [2]

In this paper, two cases are presented: in the first case, we start from the premise that a machine cannot climb a slope when the system is not active, its speed being reduced or even becoming null, and in the second case when the other car arrives and the system is inactive, it will not slow down, causing an impact.

This work was realized in the current context of application development with microcontrollers, which use sensor networks for data acquisition and transmission to the implemented system.

The following objectives were pursued:

- achieving the control algorithm of the two subsystems;

- designing the electronic control system;
- implementing of the proposed system;
- implementing the control algorithm in a program loaded into a microcontroller, the application kernel.

2. THE ARCHITECTURE OF THE SYSTEM

The circuit will be powered at 6VDC, low-cost components will be used without affecting the network performance.

The structure of the harvested part is presented in FIG 2. The core of the application is a PIC microcontroller on which the algorithms are implemented for setting the two subsystems.

Inputs to the system are:

- analog, from the speed potentiometer and the remote sensor;
- numerical, from the activation switches of the control subsystems and the proximity sensor used to determine the speed of the drive wheels.

The system output is PWM (Pulse Width Modulation) type, used to control the DC motor speed via a driver.

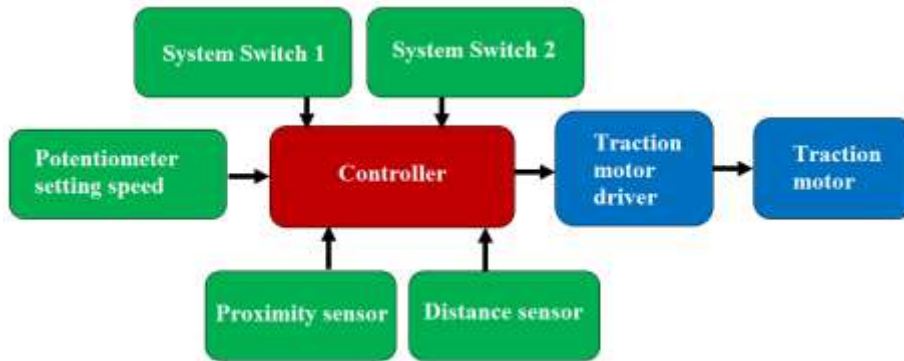

FIG. 2. The block diagram of the control system

Designing and building the electronic module is presented in FIG. 3.

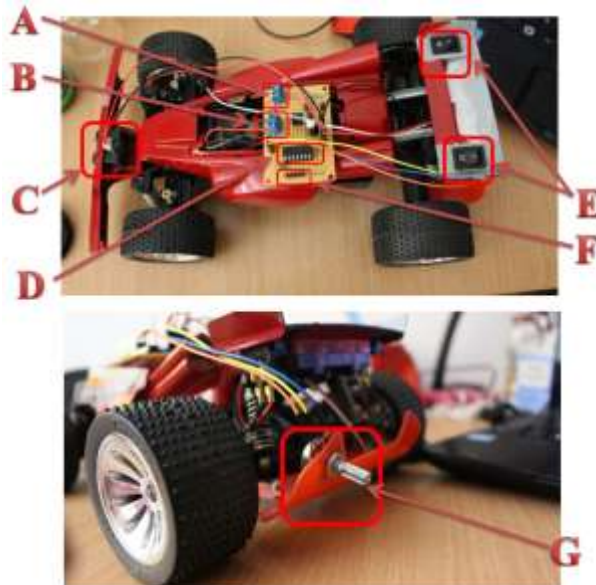

FIG. 3 A. 6Vcc power supply, B. 6Vcc power supply, C. distance sensor, D. microcontroller PIC16F1825, E. System ON / OFF buttons, F. pins for the PicKit3 programmer, G. potentiometer

The notion of proximity refers to the degree of proximity between two bodies; in technical installations there are cases in which the control of the position of a device relative to another is part of the technological process itself. Position control between moving devices, one of which represents the reference system, is done by proximity sensors. This control is exerted without direct contact between moving bodies [3].

Proximity sensors are devices that allow detecting and signaling the presence of objects in their field of action without physical contact with the respective objects. Proximity sensors have a relay feature – all or nothing – the output signal represents the presence or absence of the controlled object. [4]

For engine control a low power transistor (BD139) commanded by a small power transistor (BC109) were used, both in Darlington connection.

The simplest way to control and to obtain a variable speed, are the DC motors because the higher the applied voltage the faster the speed is. A positioning movement is composed of an acceleration, a steady speed and a braking, according to an illustrated speed trajectory (FIG. 4) [5]

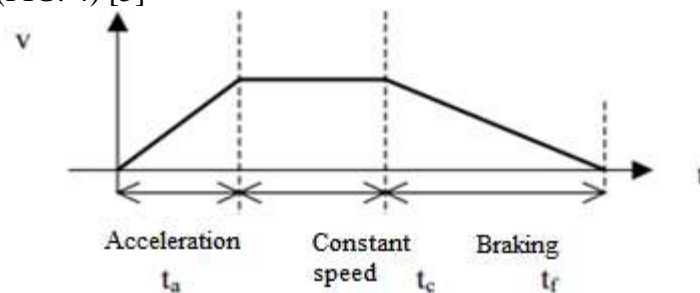

FIG. 4. Speed Trajectory

2.1 Designing the control system. The electronic layout of the assembly was performed in Proteus. In FIG. 5 the electronic scheme of the system, and in FIG. 6, the circuit implemented on the machine are presented, respectively.

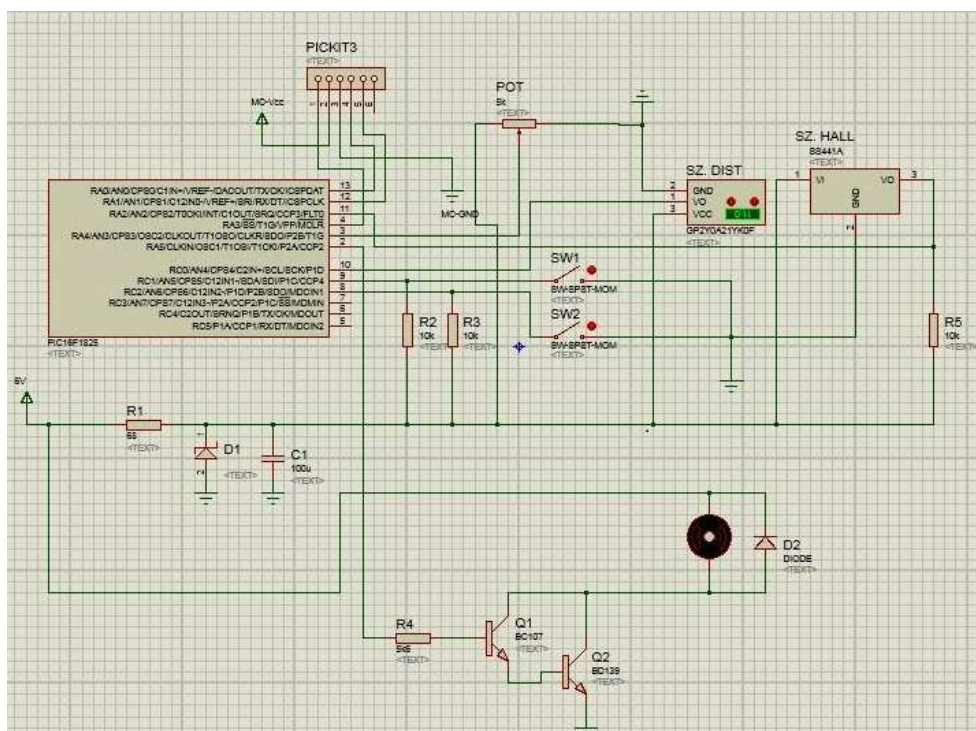

FIG. 5. Electronic diagram

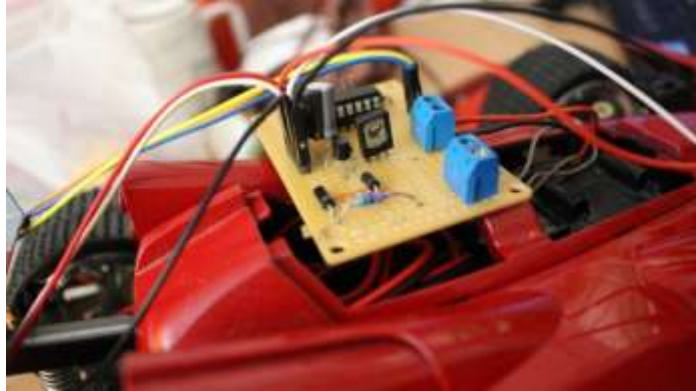

FIG. 6. The implemented circuit, mounted on layouts

3. SYSTEM FUNCTIONALITY

The operation of the cruise control subsystem of the vehicle is shown in FIG. 7. Vehicle speed (indirectly given by engine speed and wheel diameter) is prescribed by a potentiometer changing the potential at the analogue input to which it is coupled, and finally the prescribed fill factor of the PWM signal (DCpr) [6].

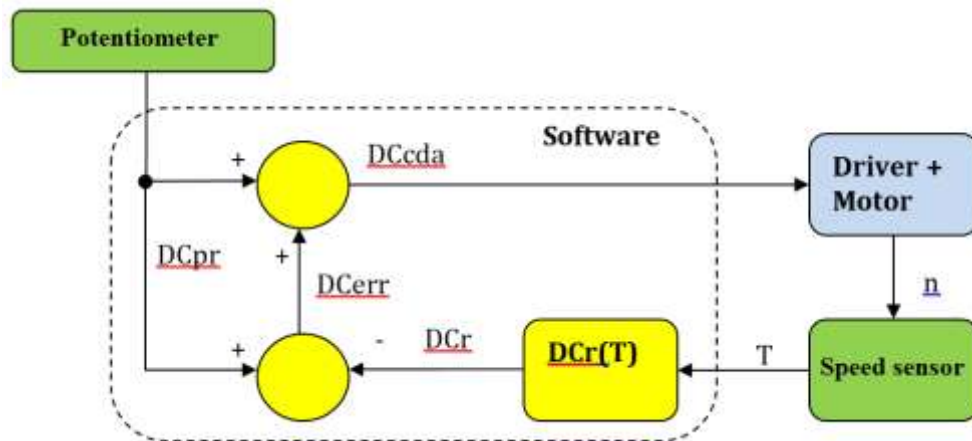

FIG. 7. Cruise Control Subsystem

The effective control of the engine is exerted by the DCcda signal which is influenced by the DCerr error signal, according to the relationship (1)

$$DCcda = DCpr + DCerr \quad (1)$$

The DCerr signal is obtained by comparing the DCpr prescription signal with that obtained through the DCr loop, according to the relationship (2)

$$DCerr = DCpr - DCr \quad (2)$$

The DCr signal is the reflection of the engine speed through the signal period obtained from the proximity sensor T according to the experimentally determined relationship (3):

$$DCr = 112 - T/2 \quad (3)$$

In this way, the decrease of the speed due to the additional load is compensated by increasing the supply voltage (increasing the filling factor) until the error is canceled.

3.1 Experimental results. The analysis of results led to the conclusion that this system controlled by a microcontroller is applicable to various classes of users, being a safety and resource-enhancing system.

In the first case, immediately after gluing the magnets, we tested at which distance the sensor reads the magnet, and then attached it to the demonstration car, as seen in FIG. 8.



FIG. 8. Hall sensor and/with magnets on the engine wheel – test

After reading the sensor of the 5 magnets, a rectangular signal was obtained uniformly as in FIG. 9.

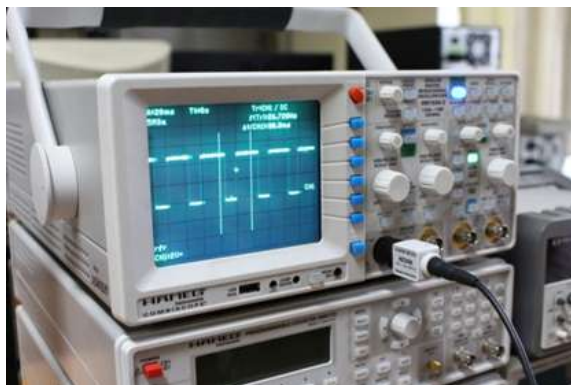

FIG. 9. The signal from the proximity sensor

Thus, the whole system fits into the current control and safety trends focused on the occupants of the vehicle. The signal from the proximity sensor varies depending on the speed of the motor that is regulated by the potentiometer, to reach the optimal operating speed to not climb the slope without activating the system, and when the system is active to increase engine power as much as it takes to climb the slope.

For the second case, to detect another vehicle in front, we used a remote sensor. When the vehicle runs on the road without other automobiles around, the cruising speed is the one intended by the driver. However, as soon as it approaches the rear of another vehicle at a prescribed distance $DistPr$ (FIG.10), the system reacts by lowering the speed until it becomes equal to the cruising speed of the vehicle in front. If the distance between vehicles remains at the limit value, the vehicle's speed is maintained. If the distance tends to increase, then the travel speed increases, but not more than the prescribed speed of the potentiometer.

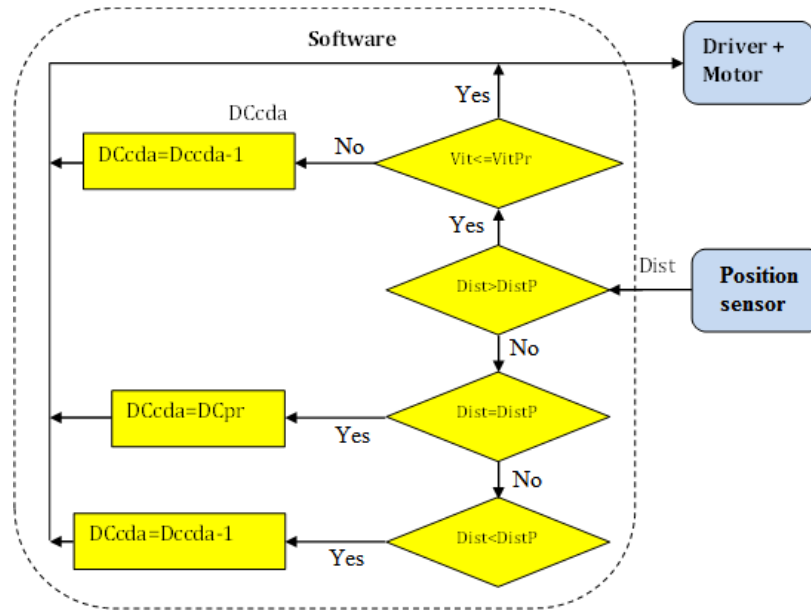

FIG. 10. The distance to the front vehicle control system

CONCLUSIONS AND FUTURE WORK

The proposed system worked according to the experimental results. The car worked in the way we intended, climbing the slope without problems and avoided a crash in a the due time. This is an active safety system for both the driver and the passenger.

In the future, for steady downhill speed of the vehicle and to make it brake faster, it is necessary to control the DC motor in both directions by means of an H-bridge and the associated driver and thereby achieving braking. This is a drawback for the system, because it does not stop in time when the car goes downhill, the speed becomes too high and can produce an accident.

REFERENCES

- [1] ***, *Driving the Future of Automotive Electronics*, online resource accessed in April 24, 2018, at the address http://www.infineon.com/dgdl/Infineon-Automotive_Application_Guide-ABR-v00_00-EN.pdf?fileId=db3a30431c48a312011c6696b47402cc
- [2] ***, *Autoweb's Guide to... Adaptive Cruise Control*, online resource accessed in July 13, 2017, at the address <http://editorial.autoweb.com/autoweb-guide-to-adaptive-cruise-control/>
- [3] - <http://mecatronicastiintaviitorului.wikispaces.com/file/view/Curs-Senzori.doc>
- [4] - ***, *Sensors. Direct order. Representation of information*, online resource accessed in November 26, 2017 at the address <https://www.scribd.com/document/114438408/Senzori-Comanda-directa-Reprezentarea-informatiei#>
- [5] P. Ogrutan., *Fujitsu Microcontrollers and Graphics Controllers*, Ed. Transilvania University of Brasov, 2006, 182 pag, ISBN 973-635-621-3;
- [6] Ulsoy, A. Galip; Peng, Huei; Çakmakci, Melih (2012). *Automotive Control Systems*, Cambridge University Press. pp. 213–224. ISBN 9781107010116.