



"HENRI COANDA"
AIR FORCE ACADEMY
ROMANIA



"GENERAL M.R. STEFANIK"
ARMED FORCES ACADEMY
SLOVAK REPUBLIC

INTERNATIONAL CONFERENCE of SCIENTIFIC PAPER
AFASES 2013
Brasov, 23-25 May 2013

MICROCONTROLLER BASED SYSTEM FOR ACCELERATED RELIABILITY TESTS FOR ELECTRONIC EQUIPMENT

Petre Lucian OGRUTAN*, Lia Elena ACIU*

*Electrical Engineering and Computer Science Faculty, Transilvania University of Brasov, Romania

Abstract: *The paper presents an embedded system that command an accelerated reliability test applied for electronic recording equipment, which is plugged into the network. Before using an electronic device in a military application it has to be tested in conditions of maximum demands or beyond the maximum demands. The proposed system can generate programmable cycles of power and temperature variations. The novelty is that the system can couple and decouple the voltage in controlled moments of time to ensure the worst case for the device to be tested. The system is bi-directional Internet connection making it possible to work remote. The test of voltage coupling at the maximum instantaneous value is heavily disturbing, so the paper analyse also a network filter structure.*

Keywords: *embedded systems, circuit simulation,, electromagnetic compatibility, power filters*

1. INTRODUCTION

Nowadays, embedded systems have permeated various aspects of industry. Therefore, we can hardly discuss our life or society from now on without referring to embedded systems. For wide-ranging embedded systems to continue their growth, a number of high-quality fundamental and applied researches are indispensable [1].

Embedded systems give us the ability to put increasingly large amounts of capability into ever-smaller devices. Electrical and computers engineers working with embedded systems contribute to all aspects of the development process from planning and design to manufacturing and marketing [2]. "We don't build these things just to have a good time, but to solve important business problems" and "each embedded system is unique, and the hardware is highly specialized to the application domain"[3].

The authors propose an embedded system for the command of a reliability test that

should be applied to any electronic device used in military applications. The system generates variations of power and temperature in desired programmable cycles. The testing system can be used for network-supplied equipments. The proposed system provides connecting and reconnecting at power network in controlled moments to ensure the worst case for equipment testing.

The first achievement of the authors in this area was in 1995 when it was made a test stand of the commutated voltage source for selecting the sources with the highest reliability.

The reliability problem is important in the military field, especially if the missiles have to be kept in long time conservation. The paper [5] analyzes the risks that electronic devices do not function when you use.

The issue of reliability of electronic devices that equip guided missiles is set in [6] where it proposes a method of software analyzing from which emerges the necessity of selection methods.

Paper [7] analyses the effect of interruptions in supply voltage in accelerated reliability tests. It said in the paper that voltage sags or power failure can cause earlier malfunctions.

The paper [8] refers to the standard 9592A, "Performance Parameters for Power Conversion Devices" which includes description of Highly Accelerated Stress Tests. The paper said that tests type Burn-in are not sufficient and that the tests should be accelerated.

2. ACCELERATED TESTING SYSTEM DESCRIPTION

The block diagram of the accelerated reliability testing system is given in Figure 1.

The test unit is supplied by a transformer with secondary tap which can be switched by the microcontroller with relays. Switching sockets provide both higher and lower voltage than the nominal one.

Microcontroller performs a test configuration on which overvoltages and undervoltages succeed; their duration, the number of repetitions and the sequence is programmable.

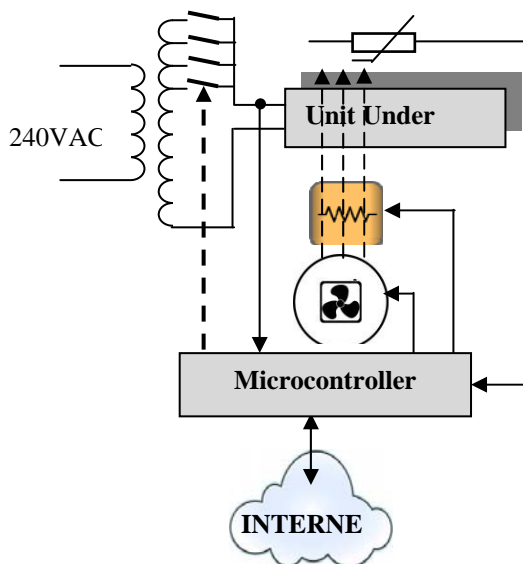

Fig. 1. Block diagram of accelerated test system

Usually, typical test parameters for voltage amplitude variation according to EN 61000 and DIN VDE 0160 are of $\pm 8\%$ or $\pm 16\%$ for periods of 2-3s, then 3-7s nominal

amplitude, Figure 2.

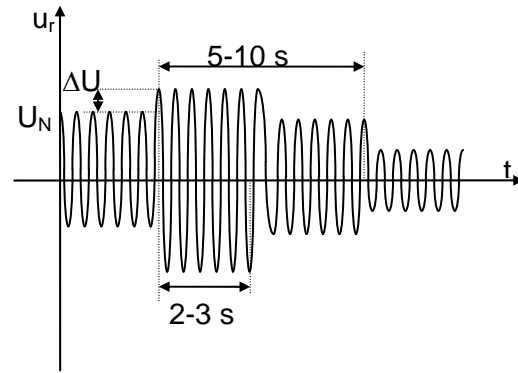

Fig 2. Voltage amplitude variation applied to UUT (unit under test)

The test temperature is ensured through heating and cooling cycles. A fan ordered by the microcontroller provides ventilation and a heating resistance provides heating. Heating and cooling cycles succeed regularly and their duration is programmable. A thermistor measures the temperature inside the device to track the process.

Another test that can be done is not to short dips. Power failure and reconnection can be scheduled to take place at any point in the sinusoidal voltage power network. Basically, the program allows the choosing of the transition moment through zero, through the amplitude and an intermediate point on the sinusoid wave. (0, 45, 90, 135, 180, etc.)

The proposed system is an embedded system based on a PIC microcontroller [9, 10], Microcontroller interrupts are determined always at mains network voltage zero-crossings, thus allowing for voltage coupling time setting and control of the execution element.

Two versions of the device were tested; one provided with a triac the other with a relay as execution elements [11].

A triac provides superior performance since it assures a more precise coupling time, yet the fact that turn-off time is uncontrollable and for certain types of loads the switching is unsafe represents a drawback. The relay eliminates the disadvantages of the triac but whenever a relay is employed, the specified closure and release times must be considered and fine adjustments should be applied after repeated trials. After testing both versions, the relay version was selected for its additional



"HENRI COANDA"
AIR FORCE ACADEMY
ROMANIA



"GENERAL M.R. STEFANIK"
ARMED FORCES ACADEMY
SLOVAK REPUBLIC

INTERNATIONAL CONFERENCE of SCIENTIFIC PAPER
AFASES 2013
Brasov, 23-25 May 2013

advantages and is presented herein.

To provide phase control, mains voltage zero crossing is signaled to the microcontroller through an interrupt. The problems arising in this case relate to a certain zero-crossing detection delay and the time needed by microcontroller routine execution to generate a priming impulse. These two processes introduce a priming delay to the triac [12].

Evaluation of mains voltage, as well as setting the accurate timing for coupling and decoupling is achieved through timer interrupt, which is initialized for every supply voltage zero crossing. Receiving commands from the web server is accomplished through reception interrupts for the RS232 interface.

Similar achievements that include switching mains voltage to the load at given times are widely used in UPS devices. When the mains supply voltage is restored, the UPS applies the load a voltage of identical polarity on the rising front of the pulse slope like the voltage provided by the DC-AC converter during the absence of the mains voltage.

A switching control algorithm is described in [13] and the hazards related to the occurrence of a short switching interval when the voltage is supplied both by the mains as well as by the DC-AC converter are described in [14].

Internet connection is made with the Site Player .The Site Player is a web server that handles Ethernet packets. The Site Player has a programmable IP such as 193.123.23.200. The communication between the Site Player and the host microcontroller is accomplished over an RS232 interface. The Site Player has eight I/O lines and a serial port. In order to configure an I/O line, the Site Player can be programmed over the Ethernet. The Web page contains a report with the coupling and decoupling times as well as the coupling and

decoupling commands.

3. NETWORK FILTERS

For the microcontroller based system were selected non-linear consumers that generate low-amplitude higher harmonics during operation. To reduce them were used network filters for the testing platform. The electric diagram of the filter is presented in Figure 3.

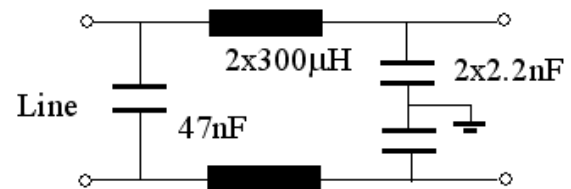
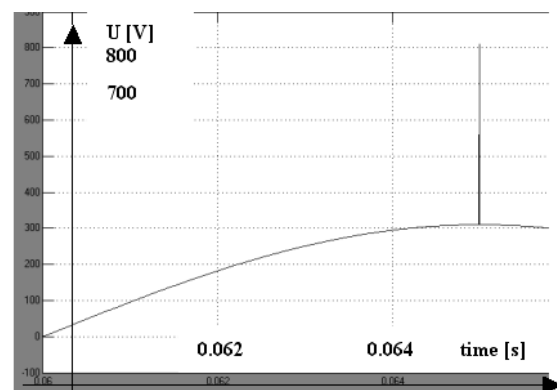

Fig. 3. Power Line filter electric diagram

Simulations were made to verify the effect of power line filter. It can be noticed that the filter diminishes the impulse amplitude to about 100V but increases its length. The same diagram was used to perform a PSPICE simulation.

The simulation waveform is shown in Figure 4 and Figure 5. As can be seen, the two simulations provided close results.



a.

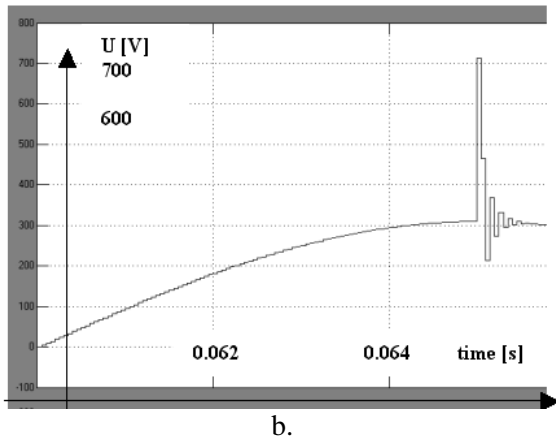

Fig. 4. Line filter SIMULINK simulation; input impulse (a) and output impulse (b).

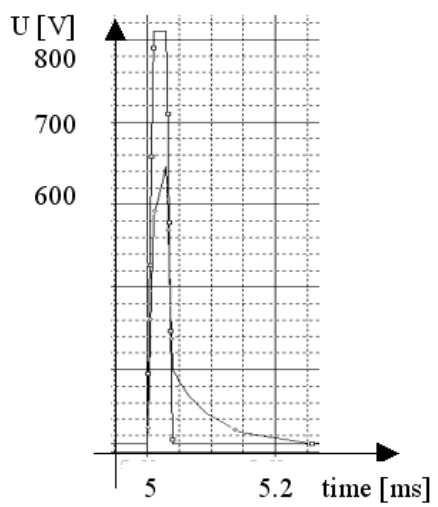

Fig. 5. PSPICE simulation waveform

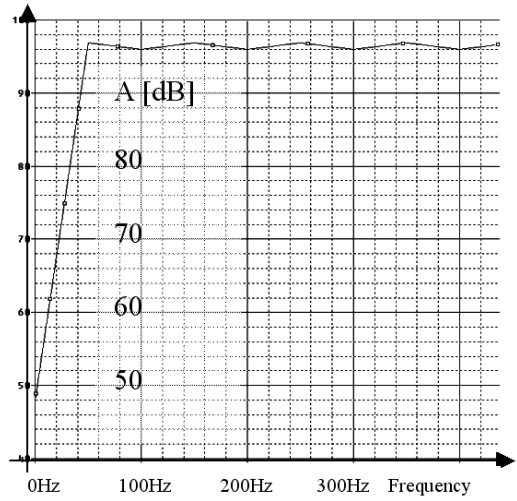

Fig. 6. PSPICE line filter characteristic

Plotting the phenomena versus time is associated with a plot versus frequency, while were simulated the frequency characteristic of the filter. Figure 6 shows a PSPICE frequency characteristic.

3. EXPERIMENTAL RESULTS

The system for accelerated reliability test was used to test several types of electronic devices. As reference, tests were done for purely resistive loads, when the waveform is completely disturbance-free. The waveform of the voltage applied at its peak value (90 degrees phase shift) as displayed on an oscilloscope screen, is shown in Figure 7.

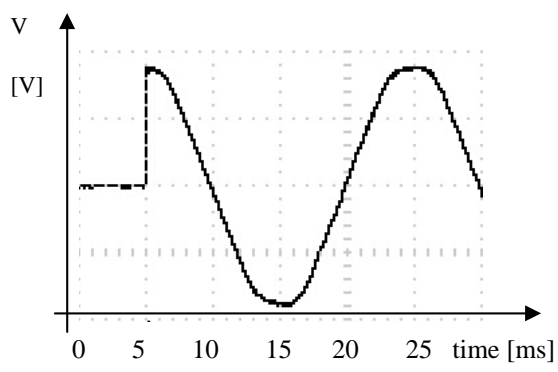

Fig. 7. Main voltage waveform for a resistive load (linear consumer)

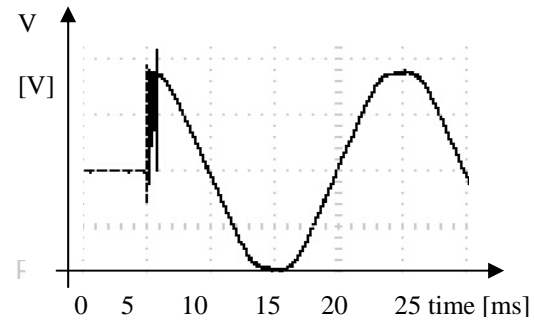

Fig 8. Voltage waveform when connecting a nonlinear consumer

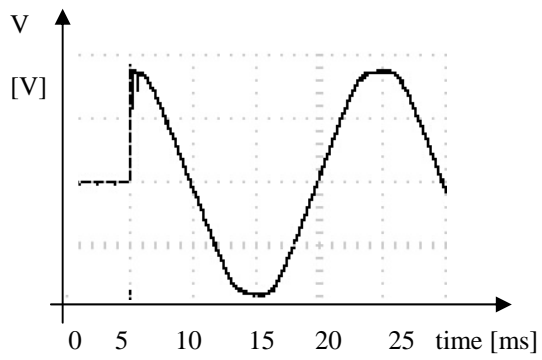

Fig. 9. Voltage waveform when connecting a nonlinear consumer over power line filter

When the consumer generates a high amount of disturbances, as nonlinear electronic



"HENRI COANDA"
AIR FORCE ACADEMY
ROMANIA



"GENERAL M.R. STEFANIK"
ARMED FORCES ACADEMY
SLOVAK REPUBLIC

INTERNATIONAL CONFERENCE of SCIENTIFIC PAPER
AFASES 2013
Brasov, 23-25 May 2013

equipment, the voltage waveform is presented in Figure 8. To reduce the disturbances generated in the network supply, filters were used. The effects of the network filter from the testing platform are presented in Figure 9.

4. CONCLUSIONS

Testing may arise in two ways:

- If the UUT can detect an error, then the microcontroller stores the number of errors at the end of the test reports it;
- If the device cannot detect the error, then, after carrying out the test, must check if the device is still operational.

The importance of reliability in military applications is undeniable. The usefulness of the proposed system may be highlight in:

- 1.The choice before purchasing a certain type of device, by testing several options and choosing the most reliable model;
- 2.Testing apparatus for specific applications that require greater security in operation and the choice of those who pass the reliability test.

The system can also be used as laboratory platform for familiarizing students with the basics of electromagnetic compatibility, testing, reliability, accelerated aging of the electronic components, embedded systems, transient state, etc.

With this system have been tested many types of devices and the results have been good. It has highlighted the difference in reliability between several types of electronic devices for fluorescent bulbs.

REFERENCES

1. Tanaka, K., *Embedded Systems Theory Design Methodology*, Online, Available: <http://www.intechopen.com/books/embedded-systems-theory-and-design-methodology> (2012).

2. Peckol. J.K., *Embedded systems: A contemporary design tool*, John Wiley and Sons, Inc. (2007).
3. Noergaard, T., *Embedded Systems Architecture: A Comprehensive Guide for Engineers and Programmers*, Newnes, (2005).
4. Ogrutan, P., Gerigan, C., *Testing PC Power Supply*, 8th Mediterranean Electrotechnical Conference (1996).
5. Xuecheng Zhang, Jingrun Ma; Jingsheng Hu; Jingjing Gong, *Storage reliability evaluation of electronic equipment from accelerated degradation testing*, International Conference on Quality, Reliability, Risk, Maintenance, and Safety Engineering (2012).
6. Huang., J., *Study of Guided weapon reliability assessment model based on bayes method*, in Proceedings of the 26th International Conference on Electrical Contacts (2012).
7. Pippola, J., Frisk, L., Kokko, K., Kiilunen, J., Marttila, T., *Effect of Input Power Interruptions on Power Electronics Reliability*, in Proceedings of the 7th International Conference on Integrated Power Electronics Systems (2012).
8. Doertenbach, N. *Power supply ESS: A case study evaluating IPC 9592A recommendations*, Reliability and Maintainability Symposium (2012).
9. Valdes-Perez, F. E., Pallas-Areny, R., *Microcontrollers: Fundamentals and Applications with PIC*, CRC Press. (2009)
10. Gaonkar, R. S., *The Fundamentals of Microcontrollers and Applications in Embedded Systems with PIC*, Delmar Cengage Learning (2007).

11. Zoican, S., *Microprocesoare si microcontrolere. Aplicatii*, Politehnica Press Edition (2011).
12. Romanca, M., Ogrutan, P., *Sisteme cu calculator incorporat. Aplicatii cu microcontrolere*, Transilvania University Press (2011).
13. Li, Y., Hong-Tao, J., *Research of a new type series-parallel converted UPS circuit and its control strategy*, in Proceedings of the. IEEE International Conference on Consumer Electronics, Communications and Networks (2011).
14. Brown, W. A., Kennedy, J. M., Linkhart, C., *Investigation of circulating ground currents occurring during UPS/generator paralleling* in Proc. IEEE Industrial and Commercial Power Systems Technical Conference (2010)